

Parts

Round Pattern Gun Shown; see page 36 for additional parts and detail views

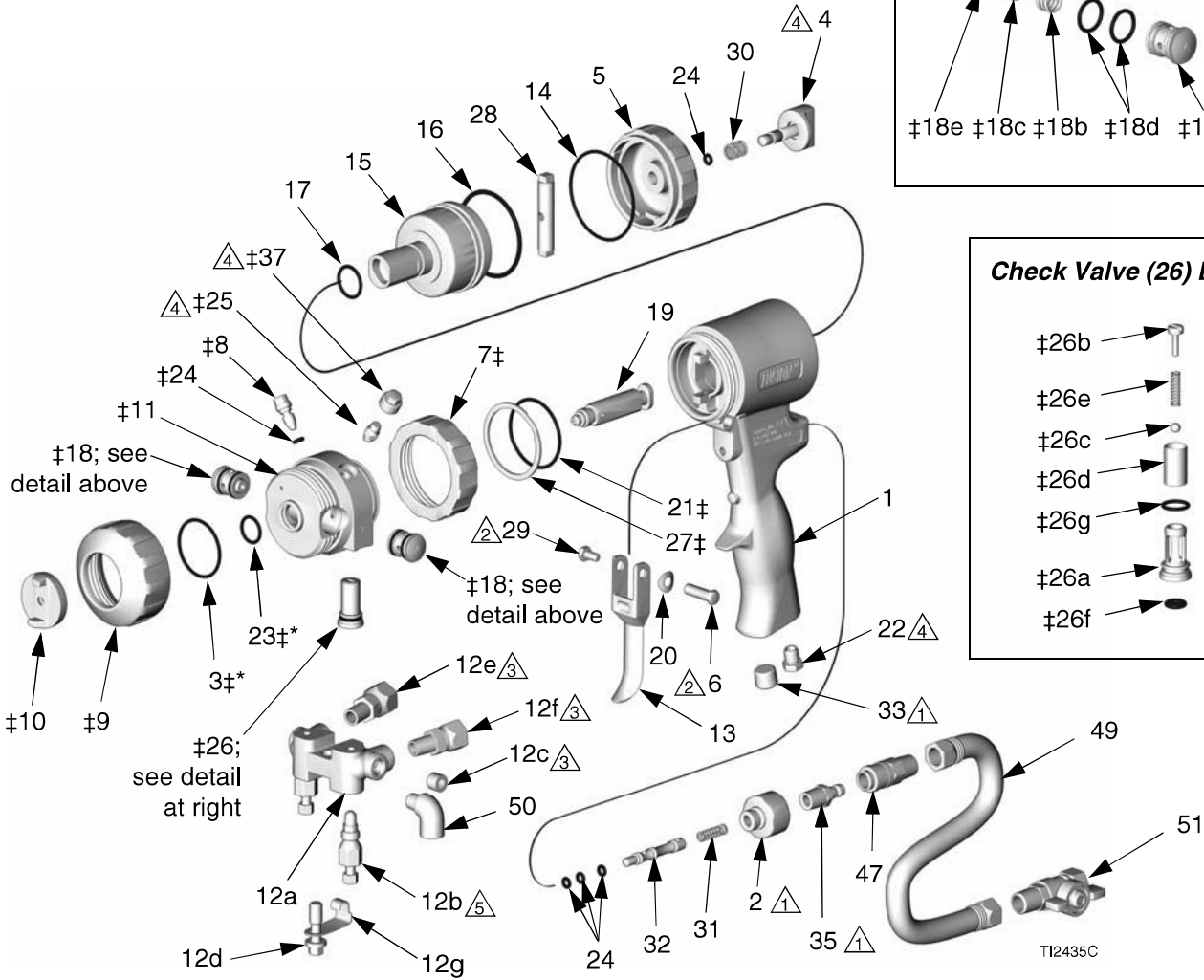

△1 Torque to 125-135 in-lb (14-15 N•m).

△2 Torque to 20-30 in-lb (2.3-3.4 N•m).

△3 Torque to 235-245 in-lb (26.6-27.7 N•m).

△4 Torque to 35-45 in-lb (4-5 N•m).

△5 Torque to 32-40 ft-lb (43-54 N•m).

Ref. No.	Part No.	Description	Qty	Ref. No.	Part No.	Description	Qty
1	15K365	HANDLE	1	22	119626	MUFFLER	1
2	15B208	PLUG, air valve	1	23†*	248131	O-RING; package of 6	1
3‡	248137	O-RING; PTFE; package of 6	1	24†*	246354	O-RING; package of 6	1
4★	15B206	LOCK, safety	1	25‡	100846	FITTING, grease	1
5★	15B204	CAP, cylinder	1	26‡	246731	VALVE, check, A side; includes 26a-26g	1
6	192272	PIN	1		246352	VALVE, check, B side; includes 26a-26g	1
7‡	15B215	RING, lock	1	26a††		. HOUSING	1
8‡	15B223	VALVE, cleanoff air	1	26b††	15B214	. SCREW; 5/16-18 x 1/2 in. (13 mm)	1
9‡	15B211	RING, retaining	1	26c‡	104396	. BALL; carbide	1
10‡	15B210	AIR CAP; for round pattern guns	1	26d‡		. SCREEN; see page 38	1
	15B801	AIR CAP; for flat pattern guns; not included in Front End Replacement Kit 246361; see Detail Views , page 36	1	26e‡	117490	. SPRING	1
◆	15D973	AIR CAP, for spatter pattern gun; not included in Front End Replacement Kit 246361; see Detail Views , page 36	1	26f†*	248133	. O-RING, check valve face; package of 6	1
11‡	246491	HOUSING, fluid	1	26g†*	248129	. O-RING, check valve housing; package of 6	1
12	246012	MANIFOLD, fluid, 2-hose; includes 12a-12g	1	27‡	116550	RING, retaining	1
	249523	MANIFOLD, fluid, 4-hose; includes 12a, 12b, 12d-12g, 50; see Detail Views , page 36	1	28★	15B205	STOP, piston	1
12a†		. MANIFOLD	1	29	203953	SCREW; 10-24 x 3/8 in. (10 mm)	1
12b	246356	. VALVE, fluid	2	30★	114070	SPRING	1
12c	100139	. PLUG, pipe; 1/8-27 npt	2	31	117485	SPRING	1
12d	15B221	. BOLT; 5/16-24	1	32	15B202	SPOOL, valve	1
12e	117634	. SWIVEL, B side; 1/8 npt(m) x no. 6 JIC(f); for 2-hose manifold	1	33	100721	PLUG, pipe; 1/4-18 npt; round and flat pattern guns only	1
	117634	. SWIVEL, B side; 1/8 npt(m) x no. 6 JIC(f); for 4-hose manifold; see Detail Views , page 36	2	35	117509	QUICK-DISCONNECT, male, air; 1/4 npt(m); round and flat pattern guns only	1
12f	117635	. SWIVEL, A side; 1/8 npt(m) x no. 5 JIC(f); for 2-hose manifold	1	36▲	222385	CARD, warning; not shown	1
	117635	. SWIVEL, A side; 1/8 npt(m) x no. 5 JIC(f); for 4-hose manifold; see Detail Views , page 36	2	37‡	15B689	COVER, grease fitting	1
12g	15B993	. SPRING, ring, lock	1	39	FTxxxx	TIP, flat; see Flat Tip Kits , page 38	1
13	15B209	TRIGGER	1	40*	246360	O-RING; PTFE; flat tip models only; package of 3; See Flat Pattern Guns , page 37	1
14★	248136	O-RING, cylinder cap; package of 6	1	43	117661	WISE, pin; dual reversible chucks; see Supplied Tools , page 36	1
15	15B203	PISTON	1	46	117792	GREASE GUN; not shown	1
16*	248135	O-RING, piston; package of 6	1	47	117510	COUPLER, air line	1
17*	248134	O-RING, piston shaft; package of 6	1	49	15B772	HOSE, air; 1/4 npsm (fbc); 18 in. (0.46 m)	1
18‡	246349	CARTRIDGE, seal, A side, SST; includes 18a-18e	1	50	112307	ELBOW, street; 1/8 npt (m x f); round and flat pattern guns only	2
	246350	CARTRIDGE, seal, B side, SST; includes 18a-18e	1	51	15B565	VALVE, ball; 1/4 npt (m x f); round and flat pattern guns only	1
18a†		. CARTRIDGE BODY	1				
18b	117491	. SPRING	1				
18c*†		. SEAL KIT; see page 41	1				
18d*	248130	. O-RING, cartridge body; package of 6	1				
18e*	248128	. O-RING, side seal; package of 6	1				
19		CHAMBER, mix, round; see Round Pattern Guns , page 37	1				
		CHAMBER, mix, flat; see Flat Pattern Guns , page 37	1				
20	15C480	WASHER, wave	1				
21†*	248132	O-RING; package of 6	1				



See **Detail Views**, page 36, for additional parts.

* These parts are only available in repair kits. To select a kit, refer to page 38.

† These parts are not available singly.

‡ Included in Front End Replacement Kit 246361.

★ Included in Safety Stop Assembly 248064 (includes 1 of item 24).

▲ Replacement Danger and Warning labels, tags, and cards are available at no cost.

◆ Included in Spatter Tip Kit 248414 (see page 36).

Ref. No.	Part No.	Description	Qty	Ref. No.	Part No.	Description	Qty
52	15B817	MANIFOLD, gun flush; round and flat pattern guns only	1	58◆	15D972	RETAINER, tip; spatter pattern gun only	1
53	117642	NUT DRIVER, hex; 5/16	1	59◆	15D971	TIP; spatter pattern gun only	1
54	118575	SCREWDRIVER; 1/8 blade	1	60◆	248019	SEAL, package of 5; spatter pattern gun only.	1
55▲	172479	TAG, warning; not shown	1	61❖	15F240	ADAPTER, stud wall	1
56▲	15D235	SIGN, instruction; not shown	1	62❖	15F854	PACKING, tip; stud wall	1
57	117773	GREASE CARTRIDGE; 3 oz; not shown; MSDS sheet available at www.graco.com	1	63❖	15F241	CAP, air; stud wall	1
				64❖	FTM979	TIP, flat; stud wall	1

▲ Replacement Danger and Warning labels, tags, and cards are available at no cost.

◆ Included in Spatter Tip Kit 248414.

❖ Included in Stud Wall Foam Kit 249421.

Detail Views

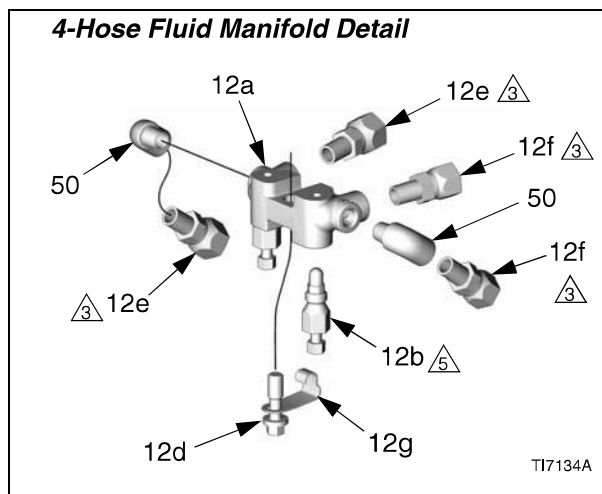
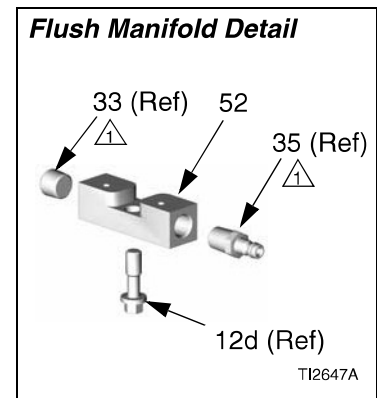
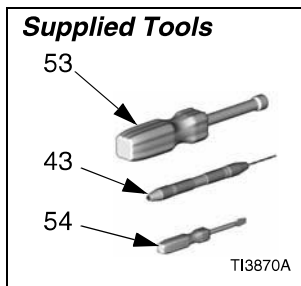
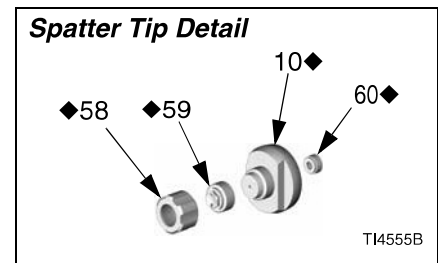
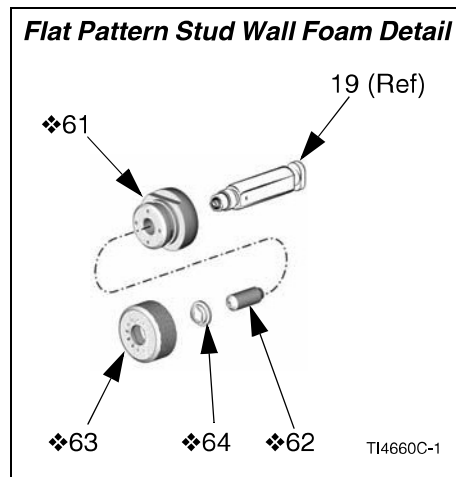
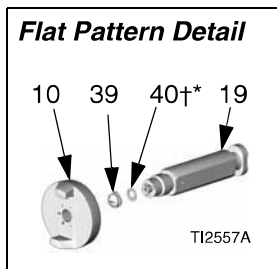

△ Torque to 125-135 in-lb (14-15 N•m).

△ Torque to 235-245 in-lb (26.6-27.7 N•m).

△ Torque to 32-40 ft-lb (43-54 N•m).