



810201, 810202, 810203, 810204

IP-02 SERIES

**2:1 RATIO TRANSFER PUMP
OPERATIONS MANUAL**



IPM, INC.

Manufactured by: International Pump Manufacturing, Inc.

IP-02 series

2:1 RATIO TRANSFER PUMP

OPERATION MANUAL and PARTS IDENTIFICATION DRAWINGS

This manual contains IMPORTANT WARNINGS and INSTRUCTIONS. Read and retain for reference.

International Pump Mfg, Inc.
3107 142nd Avenue E Suite 106
Sumner, WA 98390
U.S.A.

TEL: (253)-863-2222

FAX: (253)-863-2223

Website : www.ipmpumps.com

For Technical Service Call Your Local Distributor

Copyright 2004 by: International Pump Mfg, Inc.

Revised: January 2011

WARNING: The equipment described herein must only be operated or serviced by properly trained individuals, thoroughly familiar with the operating instructions and limitations of the equipment.

Notice: All statements, information and data given herein are believed to be accurate and reliable but are presented without guarantee, warranty or responsibility of any kind expressed or implied. Statements or suggestions concerning possible use of IPM equipment are made without representation or warranty that any such use is free of patent infringement, and are not recommendations to infringe any patent. The user should not assume that all safety measures are indicated or that other measures may not be required.

TABLE OF CONTENTS

1.0	SAFETY WARNINGS	4
2.0	INSTALLATION	8
2.1	Installation procedures	9
2.2	Additional mounting configurations	10
3.0	OPERATIONS	12
3.1	Internal pump schematics	12
3.2	Start up and adjustment of pump	14
3.3	Shut down procedure	14
4.0	MAINTENANCE AND REPAIR	15
4.1	Air motor disassembly	15
4.2	Air motor assembly	17
4.3	Disassembly – fluid section	18
4.4	Assembly – air & fluid section	20
5.0	IPM PUMP IDENTIFICATION LIST	21
6.0	PARTS IDENTIFICATION	22
6.1	Parts drawing/parts list for 810201 (Air section)	22
6.2	Parts drawing/parts list for 810201 (Fluid section)	23
6.3	Parts drawing/parts list for 810202 (Air section)	24
6.4	Parts drawing/parts list for 810202 (Fluid section)	25
6.5	Parts drawing/parts list for 810203 (Air section)	26
6.6	Parts drawings/parts list for 810203 (Fluid section)	27
6.7	Parts drawing/parts list for 810204 (Air section)	28
6.8	Parts drawing/parts list for 810204 (Fluid section)	29
7.0	REPAIR KITS	30
8.0	TROUBLESHOOTING	31
9.0	TECHNICAL SPECIFICATIONS	32
10.0	WARRANTY AND DISCLAIMER	35

1.0 SAFETY WARNINGS

Please read and observe all warnings contained in this operations manual before making any attempt to operate the equipment.

Warning

To reduce the risk of static sparking or splashing fluid in the eyes or on the skin, follow the ***Pressure Relief Procedure*** before flushing.

For your safety, read the ***Fire or Explosion Hazard*** before flushing and follow all the

Misuse of equipment

Misuse of equipment can cause serious bodily injury. Use the equipment only for its intended purpose and do not attempt to modify it in any way. Care should be taken to prevent over pressurization of the pump, hose lines and accessories connected to it. Use only IPM designated parts for re-building or repairing this equipment. Use the pump only with compatible fluids. Improper use of this equipment could result in fluid being sprayed on the skin or in the eyes of user, serious bodily injury, property damage, fire or explosion.

Daily maintenance inspection should be made on pumps and equipment and all worn or damaged parts should be re-placed immediately. Do not use pumps, components or hose lines as leverage to move equipment to avoid damage and injury.

Do not alter this equipment as doing so could cause it to function incorrectly and/or cause serious injury. Altering this equipment in any way will also void any and all warranty guarantees from the manufacturer.

Material & fluid compatibility

Always ensure the chemical compatibility of the fluids and solvents used in the fluid section of these pumps, hoses other components. Check the chemical manufacturer's data sheets and specification charts before using fluids or solvents in this pump to ensure compatibility with pumps, inner hose lining and outer hose covering.

Pressurized hoses

Because the hoses are pressurized they can present a danger should the fluid escape due to damage, worn parts or general miss-use. Escaping fluid can splash or spray operator, causing serious bodily injury and/or damage to equipment and property. Ensure that the hoses do not leak or rupture due to wear, misuse or damage.

Before each use, ensure that the fluid couplings are tight and all clips/pins/plugs are secured. Inspect the entire length of hose for wear, cuts, abrasions, bulging cover and/or loose connections. These conditions may cause the hose to fail and result in splashing or spraying of chemicals on the skin or in the eyes of operator and cause serious injury and/or property damage.

Pressure specification

The maximum working pressure of this equipment for fluids and air is *180 psi (12.5bar)*. Ensure all equipment and accessories used with this pump are rated to withstand the maximum working pressure of this pump. Never exceed the maximum working pressure of the pump, hose lines or any other components attached to the pump itself.

Procedure for pressure relief

In order to avoid the risk of serious injury to operators from splashing/spraying chemicals, the following safety procedures should be used. This procedure should be used when shutting down the pump, performing general maintenance, repairing a pump or other components of the system, replacing components or when pumping operation is ceased.

1. Close the air valve to the pump.
2. Use the air bleed down valve (see INSTALLATION, page 8) to relieve the air pressure in the system.
3. Relieve the fluid pressure by holding a grounded metal pail in contact with the metal part of the fluid dispense valve and slowly opening the valve.
4. With a container ready to catch the fluid, open the drain valve (see INSTALLATION, page 8).
5. It is a good practice to leave the drain valve open until it is time to dispense fluid again.

If you are unsure that the fluid pressure has been relieved due to a blockage in a component or a hose, carefully relieve the pressure by carefully loosening the hose end coupling to allow the fluid pressure to escape slowly. After the pressure has been relieved, the fitting can then be removed and any blockages removed.

Flush the pump before initiating operation

1. The pump is tested with lightweight DOP oil, which is left in to protect the pump parts. If the fluid you are pumping may become contaminated by oil, flush oil from pump with a compatible solvent before use. Follow the flushing instructions below.
2. When pumping fluids that set up or solidify, flush the system with a compatible solvent as often as necessary to remove build-up of solidified chemicals in the pump or hoses.
3. If the pump is being used to supply a circulating system, allow the solvent to circulate through the entire system for at least 30 minutes every 48 hours or more often if necessary to prevent settling and solidification of chemicals.
4. Lubricate the throat packing frequently, when you are pumping a non-lubricating fluid or shutting down for more than one day

Shut down & care of pump

For Overnight shut down, follow the Pressure Relief Procedure. *Always stop the pump at bottom of the stroke to prevent the fluid from drying on the exposed displacement rod and damaging the throat packing.*

Hazards from fire or explosion

Hazards exist where sparks can ignite vapors or fumes from combustible chemicals or other hazardous conditions exist such as explosive dust, etc. These sparks can be created from plugging in or unplugging an electrical supply cord or from the static electricity generated by the flow of fluid through the pump and hose.

Every part of the equipment must be properly grounded to prevent static electricity from generating a spark and causing the pump or system to become hazardous. These sparks can cause a fire, explosion, property and equipment damage and serious bodily injury. Ensure that the pump and all components and accessories are properly grounded and that electrical supply cords are not plugged in or unplugged when these hazards exist.

Should any evidence of static electricity (sparks or small shocks while in contact with the equipment) exist, discontinue pump operation immediately. Investigate the source of the static electricity and correct the grounding problem. Do not use the system until the grounding problem is repaired.

Pump and component grounding procedures

Always use the following procedures for grounding the pump. Loosen the lock screw to allow insertion of one end of a minimum sized 12 gauge wire into the bore hole of the grounding lug. Insert 12 gauge wire and tighten the lock screw securely. The other end of the ground wire must be secured to a true earth ground.

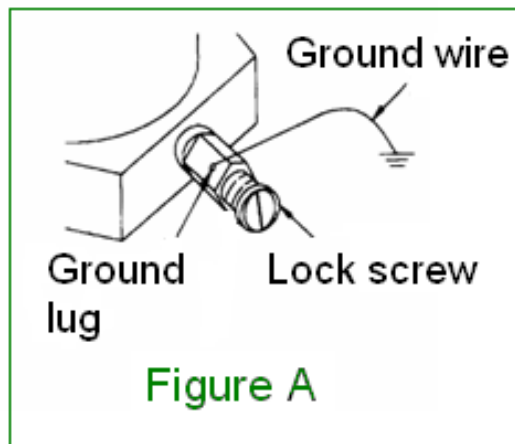

1. Air compressor: Follow the grounding procedures as recommended by the compressor manufacturer.
2. Air hoses: Always use grounded air hoses.

3. Fluid container used to supply the system: Grounding must be done according to local electrical codes.
4. Pump: Follow the procedures referred to in Figure A (page 6).
5. Fluid Hoses: Always use grounded fluid hoses.
6. Dispensing Valve: The valve must be metal to conduct through the fluid hose to the pump which must be properly grounded.
7. Dispensing Point: Grounding must be done according to local electrical codes.
8. Solvent Containers use only metal: Grounding must be done according to local electrical codes. conductive pails that are properly grounded.
9. Grounding while dispensing, cleaning or relieving pressure: Maintain conductivity by firmly securing the metal part of the dispensing valve to the side of a grounded metal container.

Hose grounding

It is very important that the hoses used for both air and fluid dispensing be a grounding type and that ground continuity is maintained at all times during operation. Regular checks of the hose ground resistance (with a resistance meter using a suitable range) and a comparison to the manufacturer's specifications will ensure that the ground is within specifications. If it is not within specified limits it should be replaced immediately.

Solvent cleaning

While cleaning the system with solvent, secure the metal part of the dispensing valve in contact with a grounded metal pail to minimize the possibility of splashing/spraying of chemicals on the skin, in the eyes and around static sparks. Use low fluid pressure for additional safety.

Hazards from moving parts

Use the *Pressure Relief Procedure (page 5)* to prevent the pump from starting un-intentionally or unexpectedly. Be aware of moving parts that present a pinching hazard to fingers or other body parts. Stay clear of these moving parts at all times when starting or operating the pump.

Safety standards

Safety standards have been established by the United States Government under the Occupational Safety and Health Act. These standards should be consulted as they apply to the hazards and type of equipment being used.

2.0 INSTALLATION

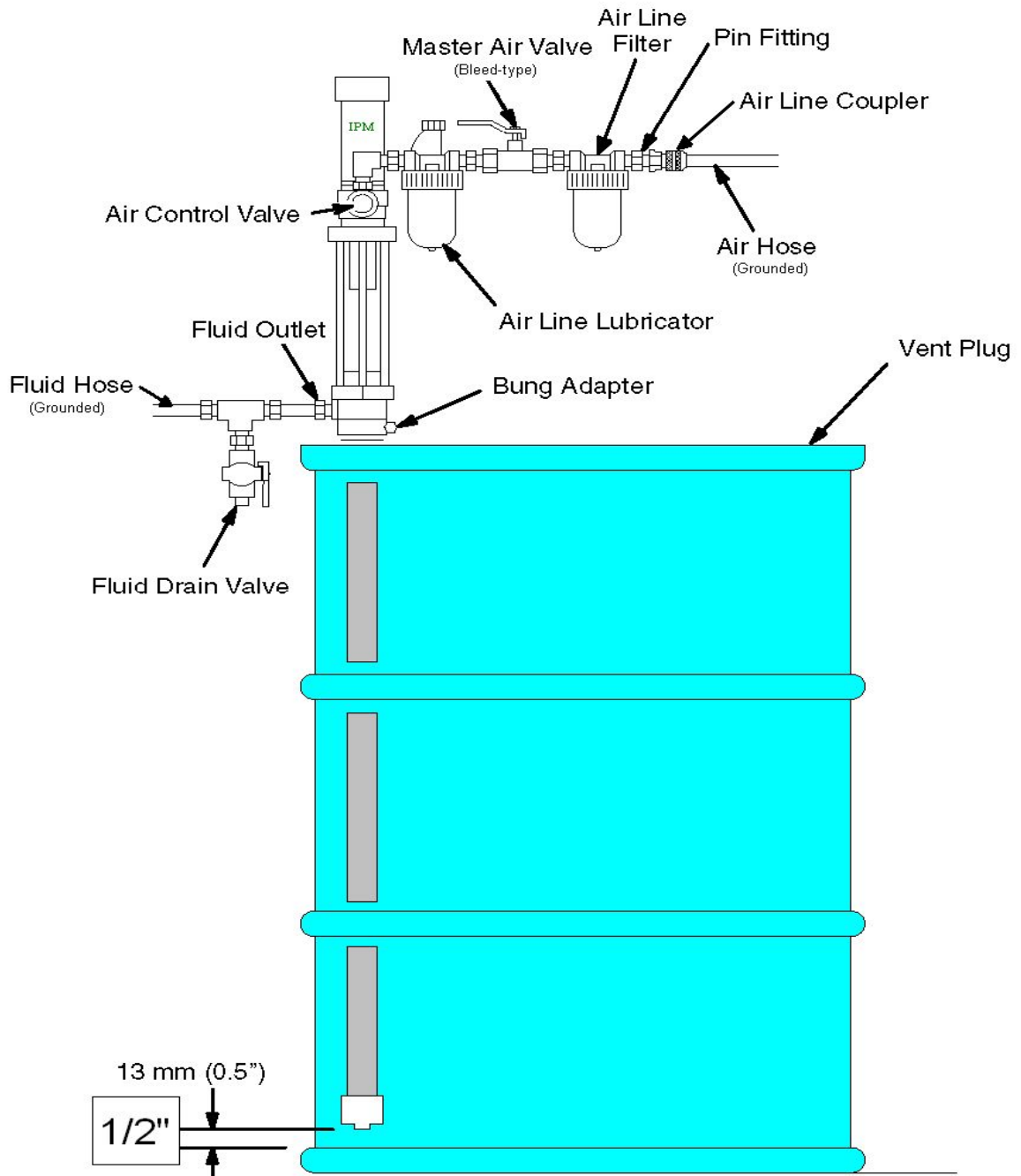

Figure B

Figure B depicts only a typical installation providing a guide for your reference but many other installation methods can be used based on your specific application. Some parts shown are not included but are sold separately. Feel free to call your **Local Distributor** for assistance.

2.1 Installation procedures

Install the necessary accessories in sequence using **Figure B** (page 8) as a guide. An air control valve (IPM part #601805) for controlling air flow is required. To minimize the risk of serious injury such as splashing/spraying chemicals on the skin, in the eyes or injury from moving parts, install the following accessories in your system.

1. **Bleed-off master air valve**

This valve will relieve the air trapped in the system after pump operation is ceased. Air that is trapped between this valve and the pump can cause the pump to reciprocate un-intentionally or un-expectantly and may cause injury to the operator.

2. **Fluid Drain Valve**

The fluid drain valve is installed to relieve fluid pressure in the pump, hose or at the dispensing valve when pump operation is ceased. The relief of pressure by the dispensing valve, which at times is inadequate if there is a clog or other restriction in the hose or dispensing valve can be achieved by using this fluid drain valve. Always use a metal valve for grounding purposes.

Lubrication

Connect an air lubricator to help achieve maximum pump longevity. The in-line lubricator provides proper lubrication to the air motor during operation. Next, install a bleed-off master air valve on the system. This valve is required on your system to relieve trapped air as explained above.

Air filters help to remove dirt and foreign particles from the supply air. Water moisture will also be trapped within this filter. Be sure to release the trapped water daily as a good maintenance practice. Connect a grounded air supply hose for main air supply.

For the fluid section, connect one fluid drain valve directly after the outlet of the pump. Be sure to connect it pointing downwards for safety. Connect a grounded fluid hose to the fluid outlet 3/4" NPT (female).

Ensure that installation is fully completed before proceeding with start up operations.

Ensure grounding of the pump and accessories is completed before beginning pump operation. Observe all OSHA and other safety regulations.

2.2 Additional mounting configurations

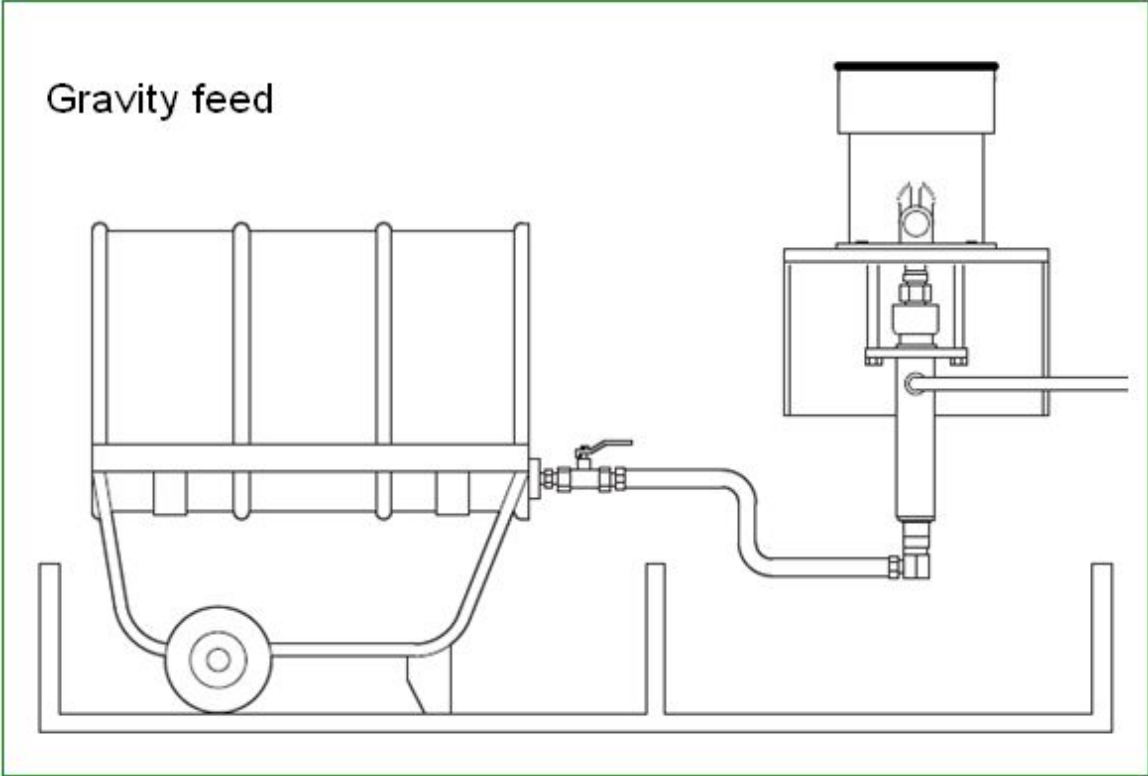
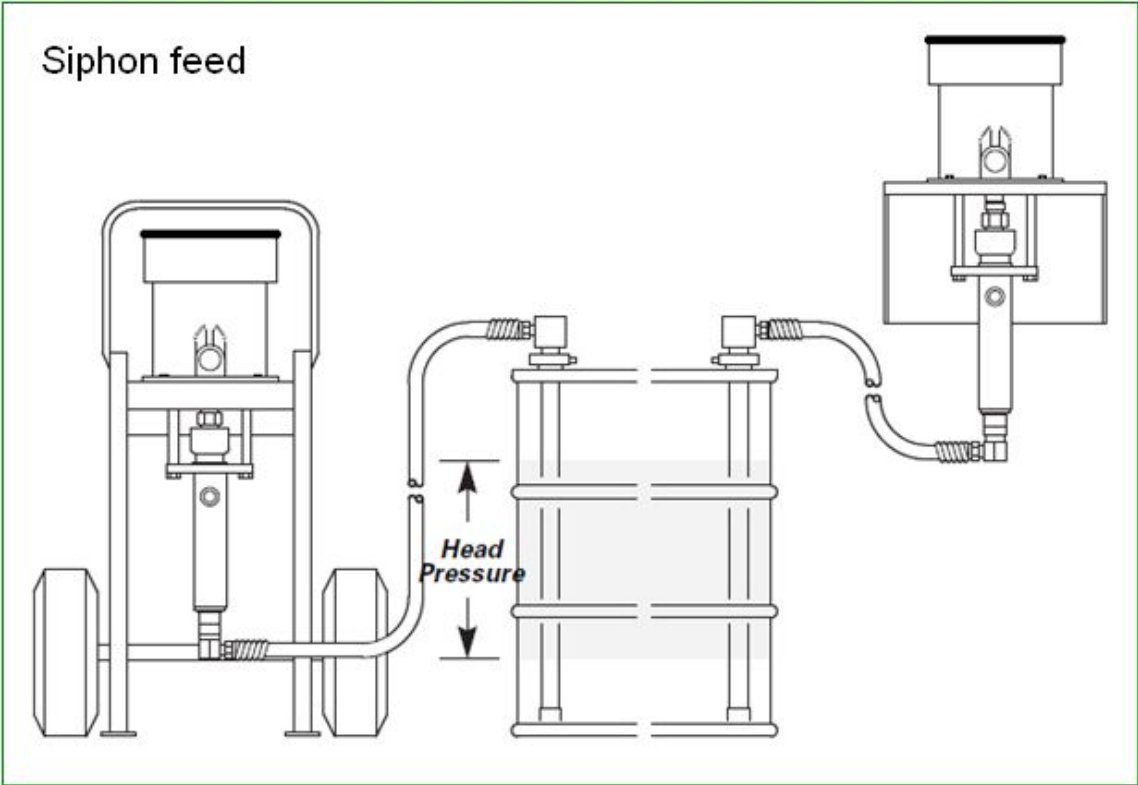

Submersion feed

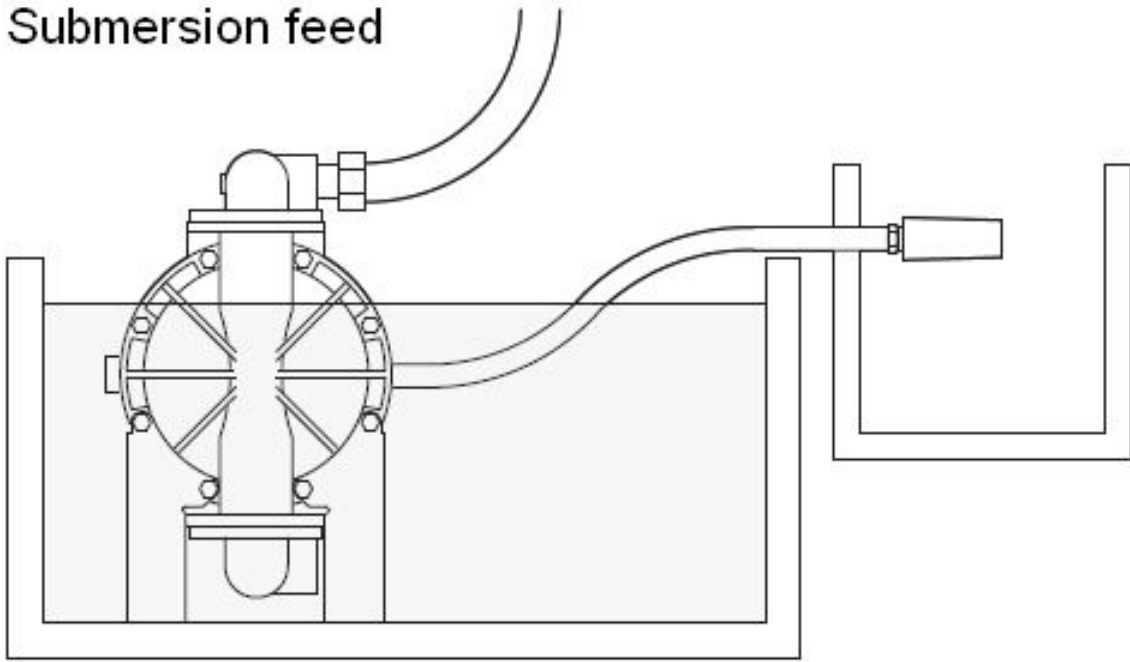

Pressure feed

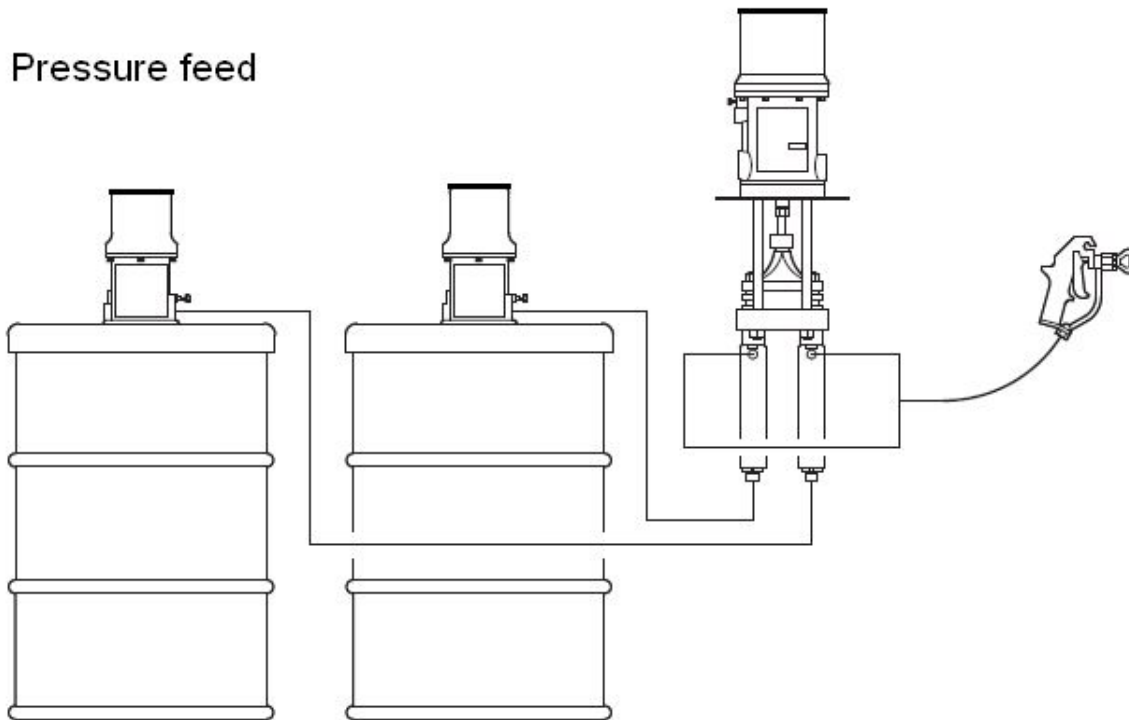

3.0 OPERATIONS

3.1 Internal pump schematics

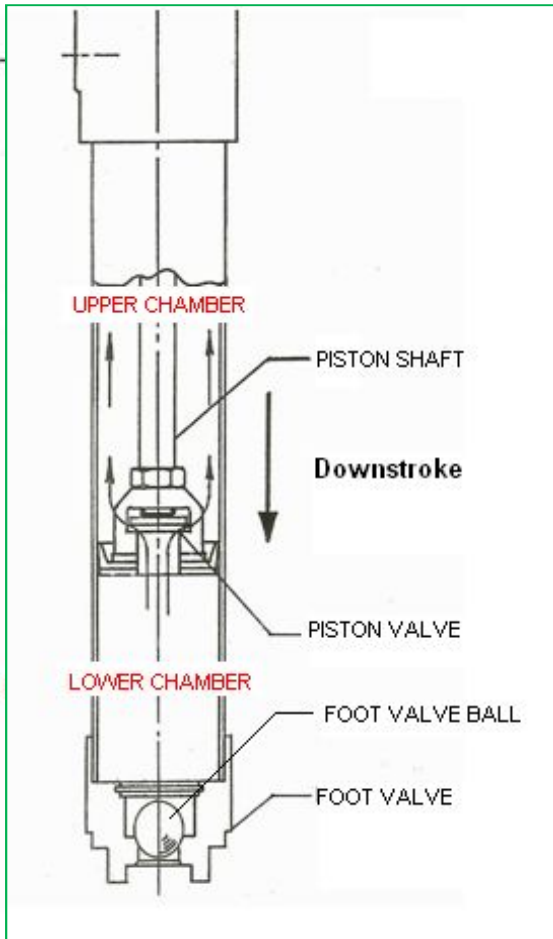

Downstroke: When the PISTON SHAFT is in the downstroke motion, the fluid that is present in the lower chamber of the cylinder moves the FOOT VALVE BALL into the closed position. The entrapped fluid then lifts the PISTON VALVE up as it flows into the upper chamber and to the fluid outlet in **Figure B** (page 9).

Upstroke: During the upstroke motion, the PISTON VALVE is closed and fluid present in the upper chamber is transferred to the outlet port. At the same time, the FOOT VALVE BALL is opened by incoming pressure and fluid is then drawn into the lower chamber.

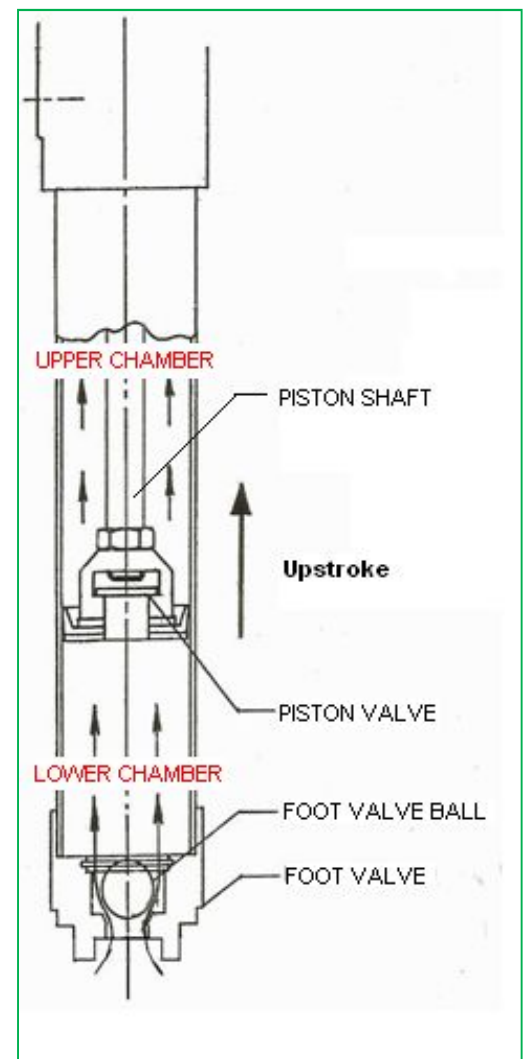

Every IPM transfer pump is a 2 stage pump system. They are designed to pump fluid on both the up stroke and down stroke during operation for optimum efficiency and output.

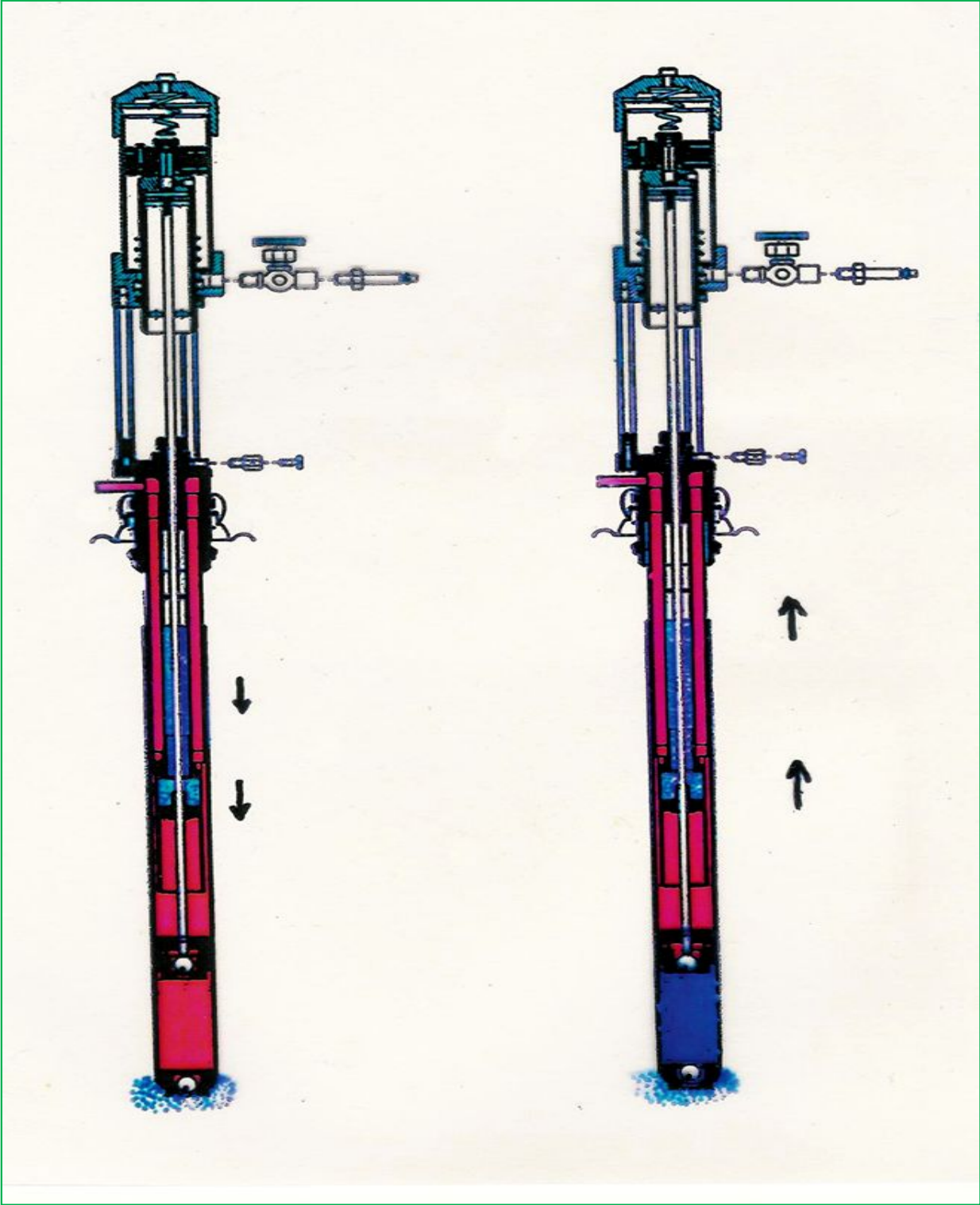

3.2 Start up and adjustment of transfer pump

1. Ensure that the air control valve is closed then open the bleed-type master air valve. Connect the quick disconnect coupler to the male fitting.
2. For safety, open the dispensing valve slowly, then drain fluid into a grounded metal container. Ensure metal-to-metal contact is maintained between the container and the valve at all times.
3. Adjust the air control valve slowly for just enough pressure to start running the pump. This is to prime all air within the system. After all the air has been expelled from the lines, close the dispensing valve. During the priming of the pump, the pump operates when the dispensing valve is opened and stops when the valve is closed.
4. Turn the air regulator slowly until sufficient flow from the dispensing valve is achieved. Remember to always run the pump at the lowest possible speed necessary to achieve what is desired. Never exceed the maximum working pressure of any component in the system.
5. The pump should not be left to run dry of the fluid being worked upon. When running empty, the operating speed will rise rapidly, increasing the chance of damage to the pump and/or components. During operation should the pump be found to run too fast, stop it immediately and ensure the fluid supply is not too low or the drum is empty. If air has gone into the system, repeat the priming procedure. Ensure that all air has been expelled from the lines before beginning operation again. Flush the pump or leave it filled with a compatible solvent when not in use.
6. Always follow the Pressure Relief Procedure should the pump be put away for any period of time or during system shut off at the end of the day.

3.3 Shut down procedure

1. Relieve the air pressure with the air regulator.
2. Open the air needle valve.
3. Bleed off residual pressure in the system with the bleed-off master air valve.
4. Open the drain valve to relieve fluid pressure in the system. Use a container to collect the fluid drained off. **Be especially careful as the fluid may still be under pressure.** Hold the metal fluid drain valve against the side of the grounded container while relieving the pressure.

Note: For long periods of shut-down, flush the pump thoroughly with an appropriate cleaning fluid to prevent solidified chemical build-up.

4.0 MAINTENANCE & REPAIR

4.1 Air section disassembly

1. Follow the *Procedure for Pressure Relief* (page 5). It is very important to relieve all air and fluid line pressure as well as pump pressure before proceeding to the next step or injury can occur.
2. Remove inlet and outlet hoses. Place the pump in a vise or other holding device. If you know that you just need to work on the air motor, the pump can simply be left in the drum it is operating in.
3. Clamp on the housing with the outlet hole against one of the jaws of the vice. When clamping the housing- either the air motor assembly or the lower tube and/or foot valve can be removed.

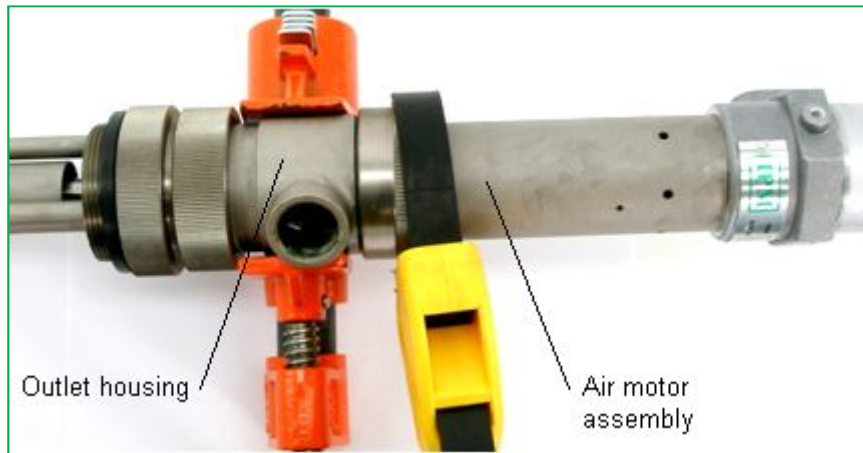

Use a strap wrench to remove the air motor assembly.



The pump assembly can be removed from the air motor by disengaging the Piston Rod.



Remove the air cylinder either by hand or by using a strap wrench.

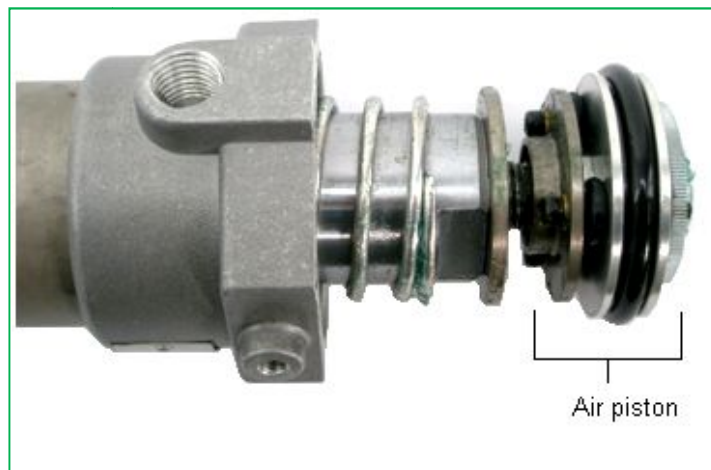

Air motor assembly and piston rod with the air cylinder removed.

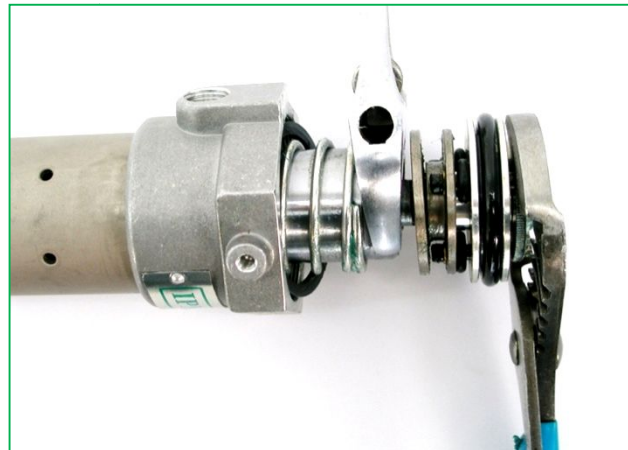

Place a pair of channel-lock pliers on the knurled area of the exhaust valve plate and a crescent wrench on the flats to remove the air piston assembly. Examine the spring in the air motor cap to ensure that it is not damaged or loose. Examine the gasket in the air motor cap and replace as needed. This gasket seals the cylinder cap to the air cylinder. Also inspect the lower return spring to ensure it is secured correctly into the air motor base assembly.

4.2 Air motor assembly

Assemble the air motor assembly in reverse order from above procedure. Ensure all parts shown in illustration below are included and in operable shape. The air exhaust valve plate and socket head screws require the use of Loctite-222 on the threads to ensure they do not vibrate loose. It is also important to check the rubber stop in the air exhaust valve plate to ensure it is secure. Tighten the screws to 10-14 inch pounds.

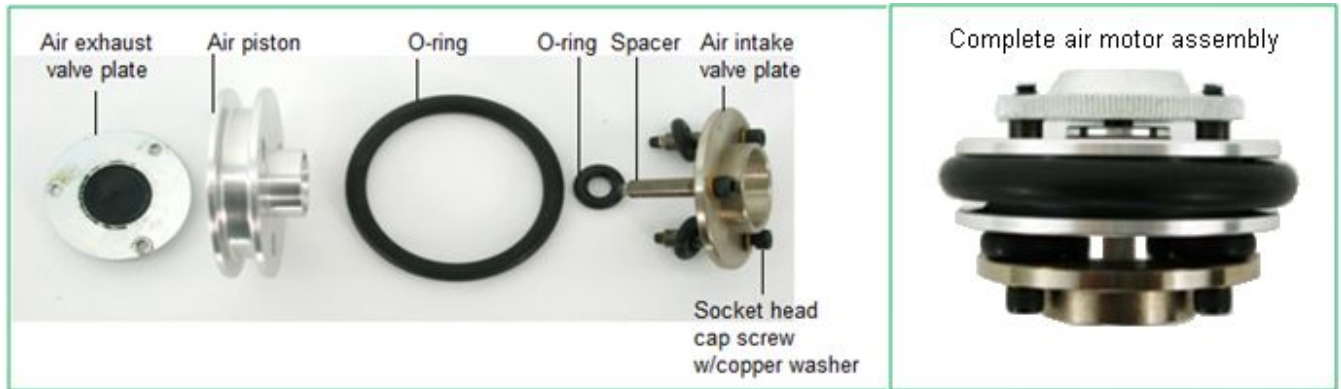

1. Assemble the air piston assembly (use Loctite-222), with washer onto piston rod. Hand-tighten only.

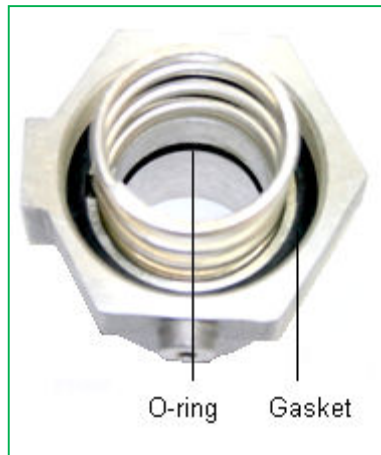

2. Place O-ring inside the machined groove in the air motor base. Place gasket in the top of the air motor base with spring centered inside the gasket, resting on the air motor base. Slide the piston rod and air valve assembly in to the air motor base.



3. Insert the conical spring into the machined groove in the air cylinder cap followed by the square cut gasket. Clamp the air motor base into a vice, using a strap wrench to re-assemble the air cylinder and air cylinder cap to the air motor base. Hand-tighten only the air cylinder cap so as not to damage the gasket.
4. Place the connecting ring around the connecting rod housing and hand-tighten.

4.3 Fluid section disassembly

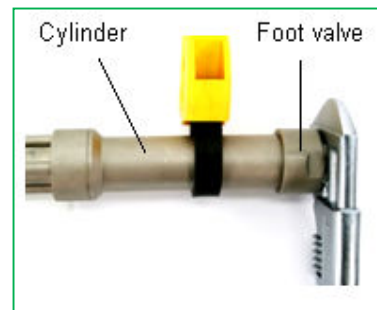

1. Remove the foot valve while holding the cylinder with a strap wrench.
2. With the upper air motor assembly already removed, you should be able to simply push from the upper ball end the complete assembly out the bottom of the lower section.

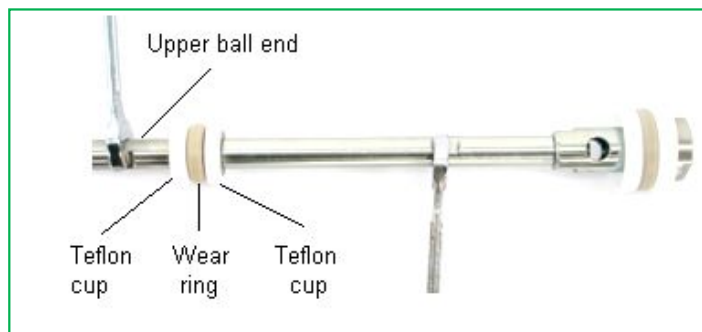

3. Use two wrenches and dismantle the upper pump section. Note the orientation of the Teflon cups. One faces up, followed by a wear ring in the center and the second cup faces down followed by a lower support washer. Use Loctite-222 when re-installing.



Breakdown of upper portion of the lower connecting rod assembly.

Breakdown of internal foot valve.

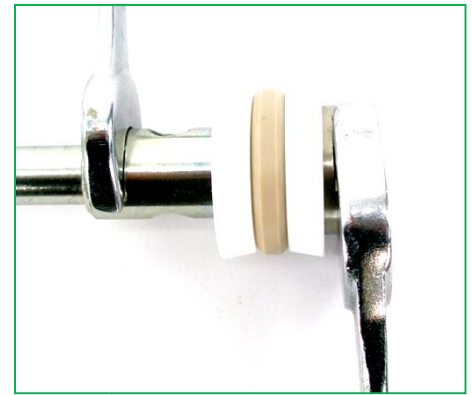

Internal foot valve disassembled. Clean, inspect or replace if necessary these components before re-assembly. Use Loctite-222 when re-installing.

After the lower piston rod is inspected and proper parts replaced/cleaned as needed, inspect the lower body assembly and make sure that they are also clean and free from any scratches. Grease and push this assembly back up from the bottom into the pump's cylinder just far enough to re-attach the foot valve.



Lower foot valve parts. On the **stubby** version of the IP02 pump there are $\frac{3}{4}$ " female pipe threads under the foot valve- on the **drum length** there are not. Should you need to extend into your container farther it is recommended to install a cylinder extension tube to keep the foot valve at the lowest possible point.

Be sure to inspect, clean and replace any of the above items if needed. You will need to re-assemble the foot valve assembly in reverse from the way that you removed it.

4.4 Securing the fluid section to the air section



The piston rod is actually inside the air motor assembly- which has been removed in the above illustration so you can see more detail.

Notice how the upper connecting rod is being inserted at an angle. This is to ensure that the ball on the end correctly engages the keyway slot in the photo on the left.

You will need to “hook” the ball in to the slot by moving the rod at an angle, then press it towards the center of the notch.

Note: the lower section will need to have the piston rod extended and the air motor will need to be in the down position in order for you to have enough length to hook these two components together.

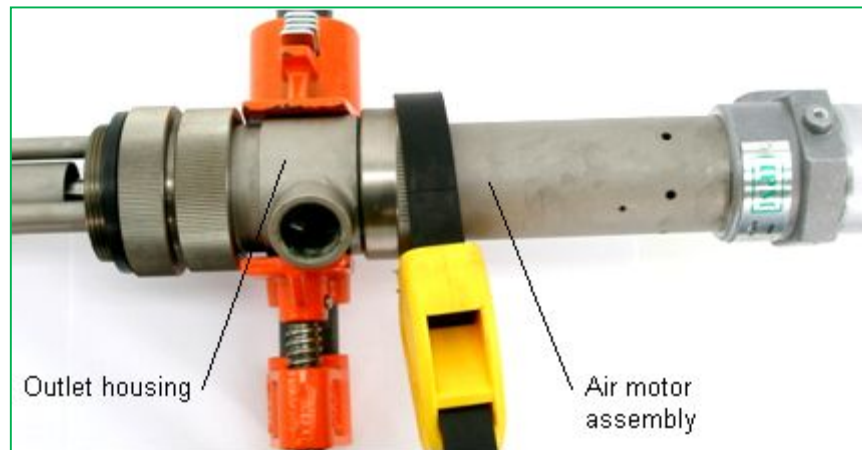

Connect the air motor section to the outlet housing as shown above.

You should now be ready to re-install the pump into your container. Attach the fluid hose first and tighten before attaching the air line and turning the air supply back on.

5.0 2011 IPM PUMP IDENTIFICATION LIST

Part #	Description
810101	Drum length Carbon steel 1:1 transfer pump
810102	Stubby length Carbon steel 1:1 transfer pump
810103	Drum length Stainless steel 1:1 transfer pump
810104	Stubby length Stainless steel 1:1 transfer pump
810105	Pail length Carbon steel 1:1 transfer pump
810201	Drum length Carbon steel 2:1 transfer pump
810202	Stubby length Carbon steel 2:1 transfer pump
810203	Drum length Stainless steel 2:1 transfer pump
810204	Stubby length Stainless steel 2:1 transfer pump
820301	Drum length Stainless steel 2:1 transfer pump
820302	30 GAL. drum, 3/4 length stainless steel 2:1 transfer pump
820303	Low ceiling, drum length Stainless steel 2:1 transfer pump
820304	Wall mount, Stubby length Stainless steel 2:1 transfer pump
820306	Drum length stainless steel 2:1 transfer pump
830802	Drum length Stainless steel 5:1 transfer pump
830803	Stubby length Stainless steel 5:1 transfer pump
840902	Drum length Stainless steel 10:1 transfer pump
840903	Stubby length Stainless steel 10:1 transfer pump
841001	Stubby length Stainless steel 15:1 transfer pump
841101	Stubby length Stainless steel 30:1 transfer pump

6.0 PARTS IDENTIFICATION

6.1 Parts drawing for air motor section Pump # 810201

700038 Complete air motor section

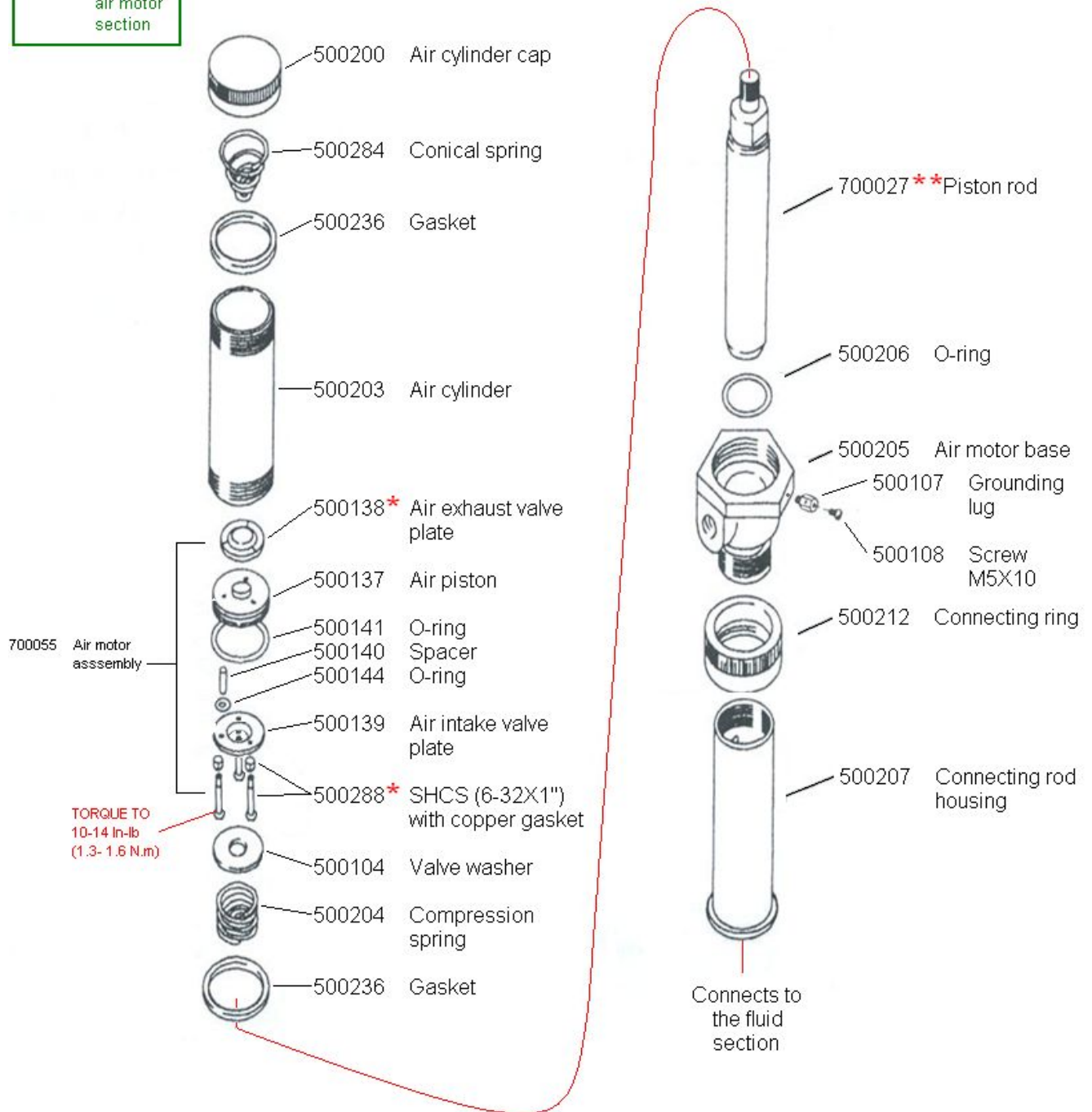

* Part number 500288 (threads) and part number 500138 require the use of T200004 Loctite to help ensure they do not come undone.

** Part number 700027 (threads) require the use of T700004 Loctite to help ensure they do not come undone.

6.2 Parts drawing for fluid section Pump # 810201

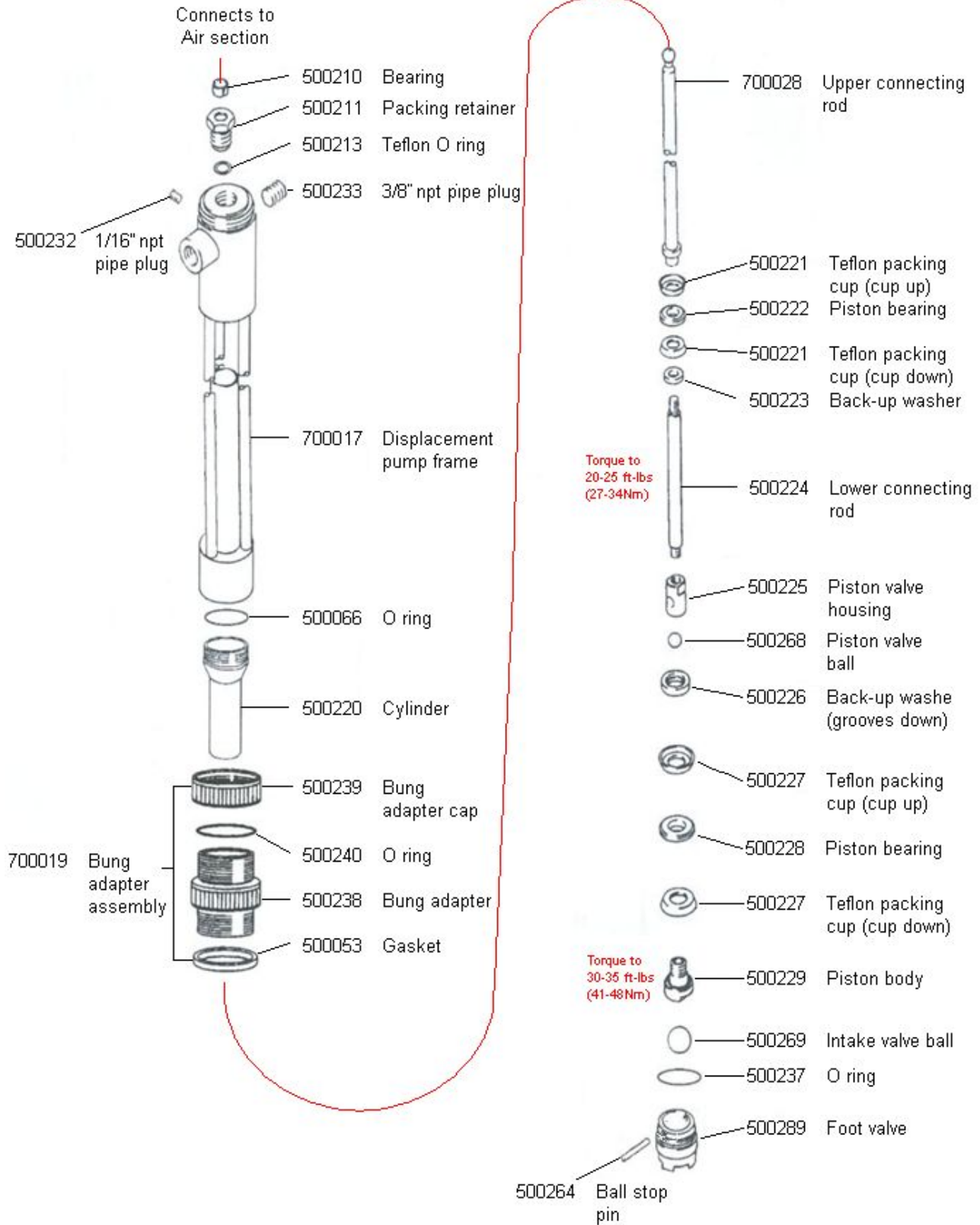

6.3 Parts drawing for air motor section Pump # 810202

700046 Complete air motor section

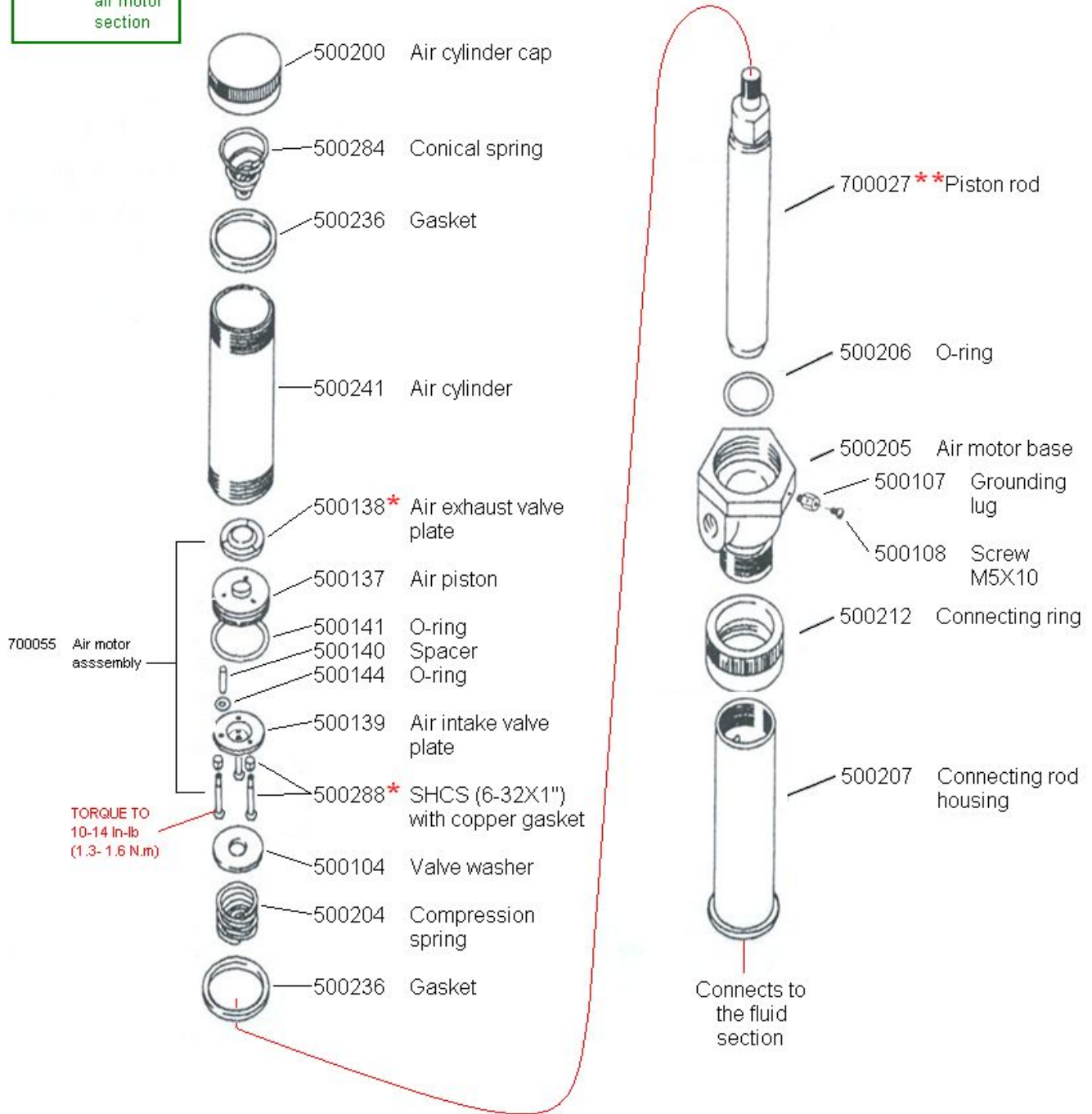

* Part number 500288 (threads) and part number 500138 require the use of T700004 Loctite to help ensure they do not come undone.

** Part number 700027 (threads) require the use of T700004 Loctite to help ensure they do not come undone.

6.4 Parts drawing for fluid section Pump # 810202

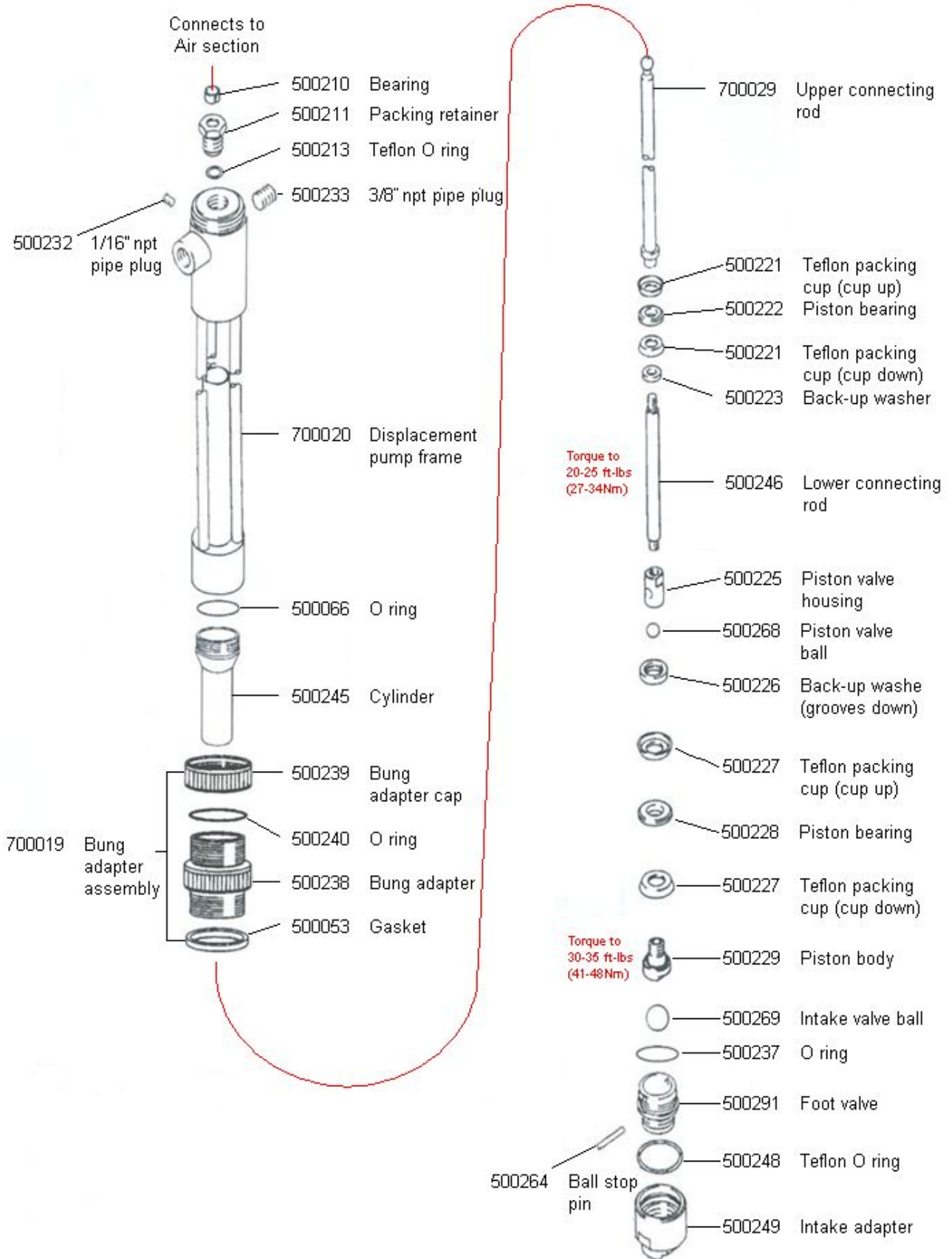

6.5 Parts drawing for air motor section Pump # 810203

700038 Complete air motor section

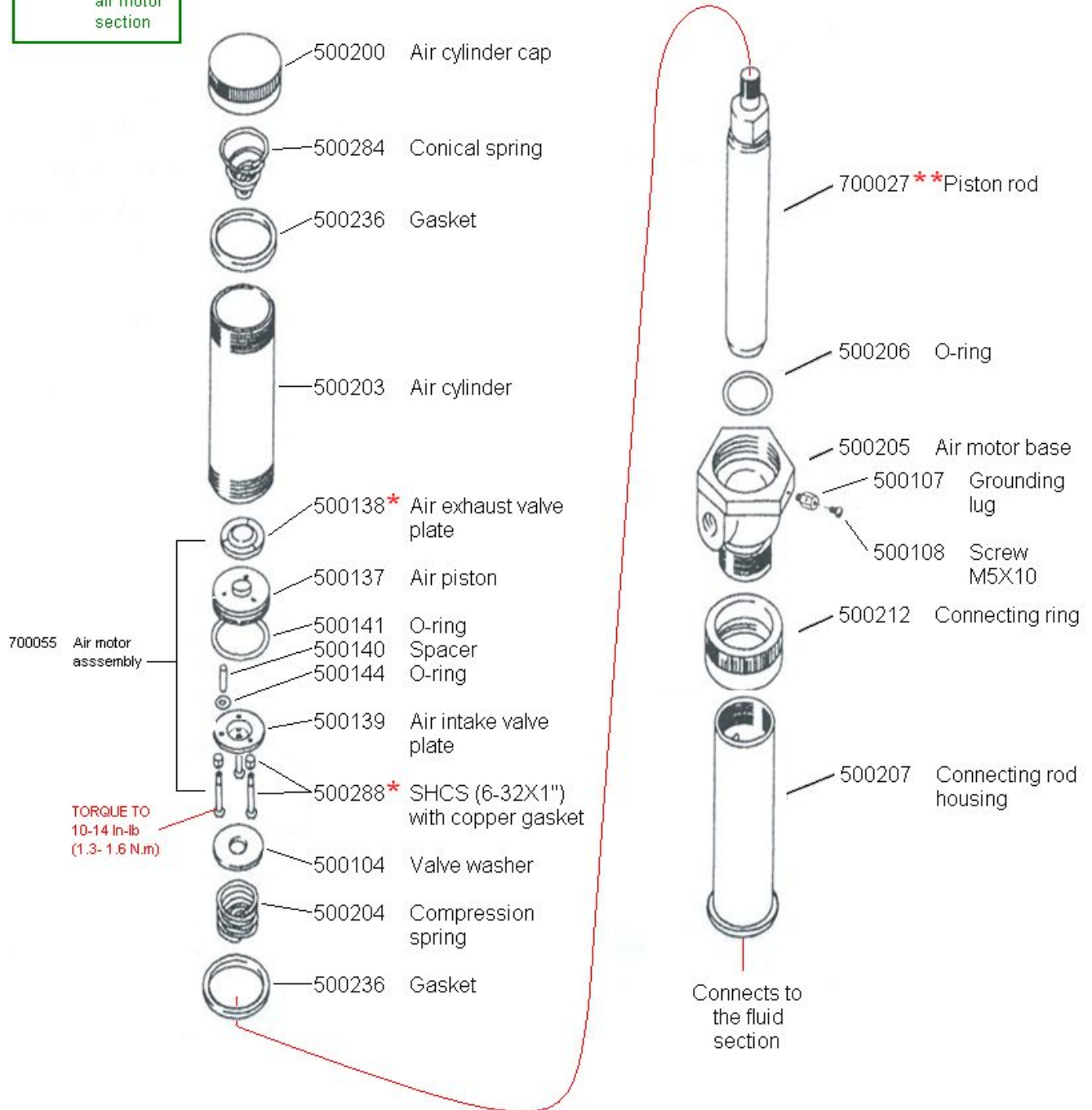

* Part number 500288 (threads) and part number 500138 require the use of T200004 Loctite to help ensure they do not come undone.

** Part number 700027 (threads) require the use of T700004 Loctite to help ensure they do not come undone.

6.6 Parts drawing for fluid section Pump # 810203

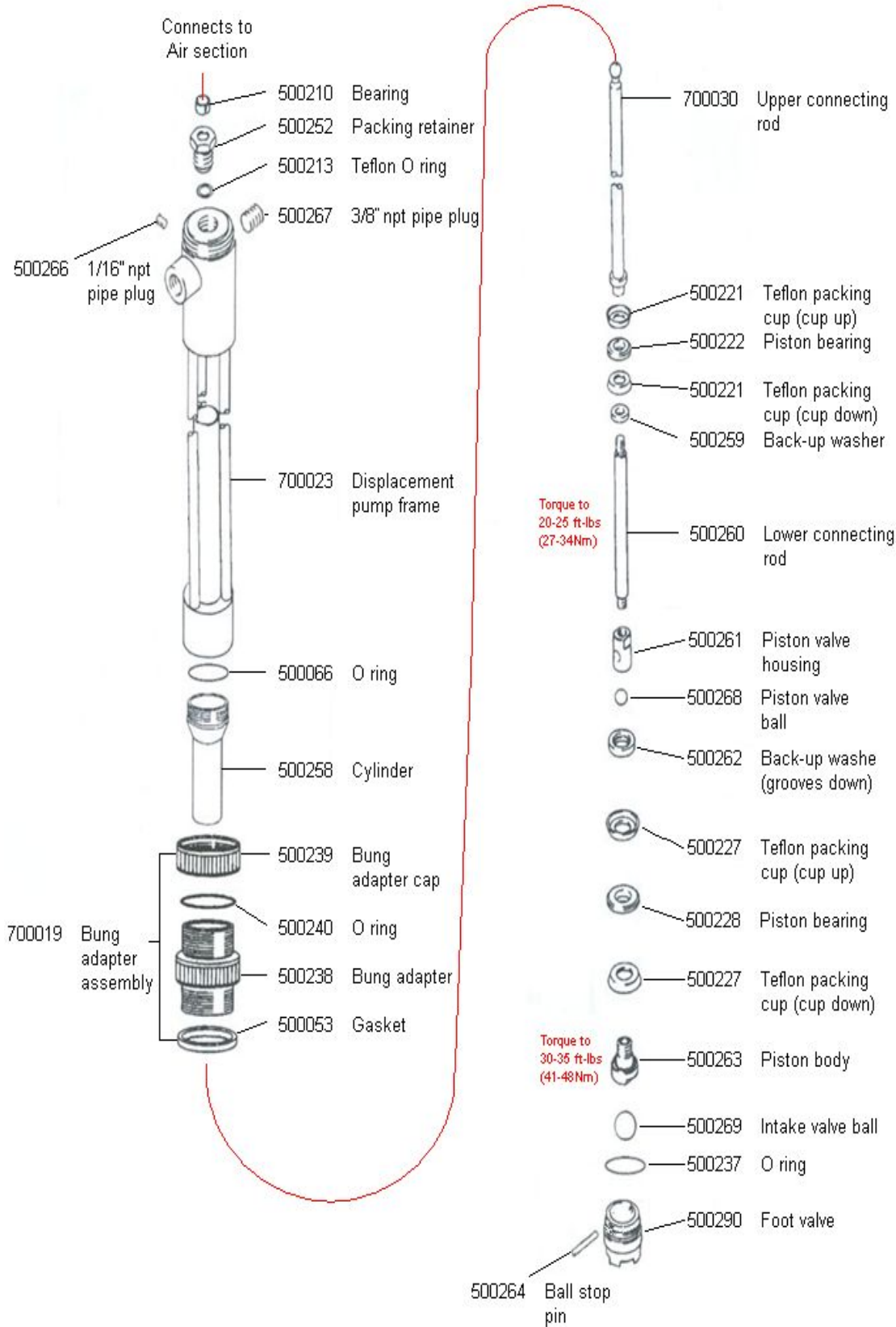

6.7 Parts drawing for air motor section Pump # 810204

700046 Complete air motor section

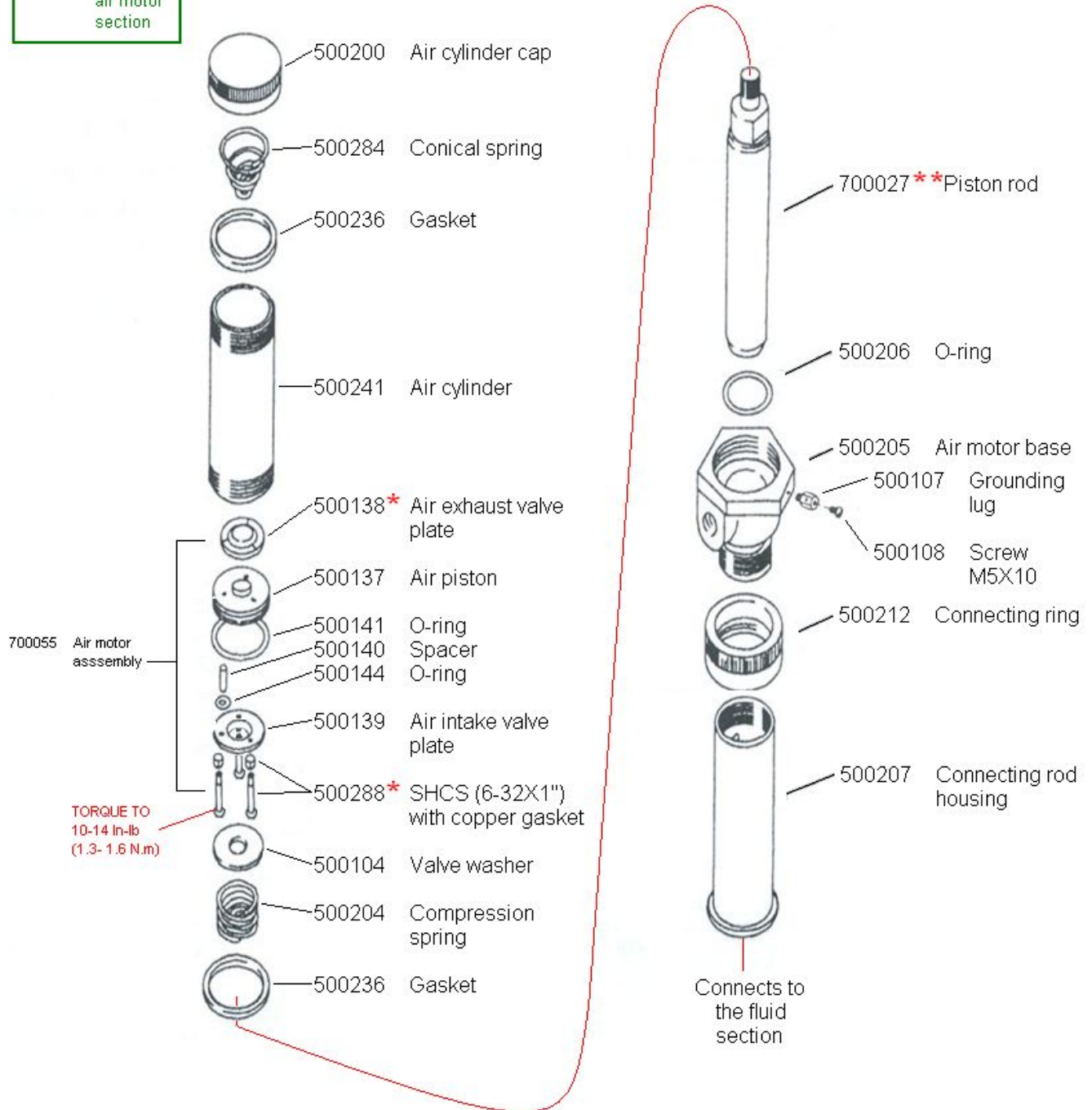

* Part number 500288 (threads) and part number 500138 require the use of T700004 Loctite to help ensure they do not come undone.

** Part number 700027 (threads) require the use of T700004 Loctite to help ensure they do not come undone.

6.8 Parts drawing for fluid section Pump # 810204

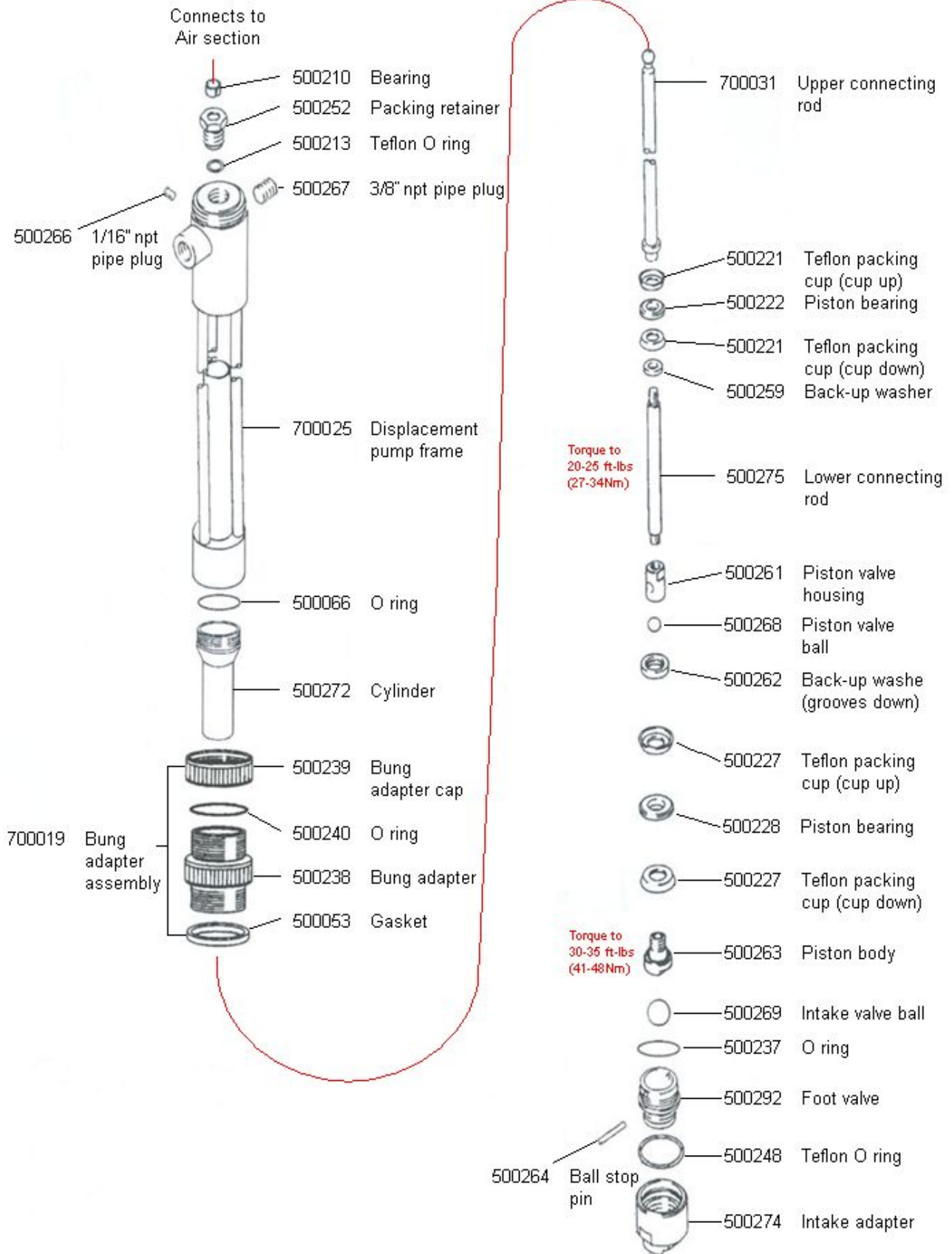

7.0 REPAIR KITS

IP02 Series – 2:1 pump repair kits

601011	Air section repair kit		
	Fits: 810201, 810202, 810203, 810204		
	Components include		
	Part #	Description	Qty
	500141	Viton O-ring	1
	500144	Viton O-ring	3
	500206	Duro-nitrile O-ring	1
500236	NBR Gasket	2	

601013	Fluid section repair kit		
	Fits: 810201, 810202, 810203, 810204		
	Components include		
	Part #	Description	Qty
	500066	Viton O-ring	1
	500210	Bearing	1
	500213	Teflon O-ring	1
	500221	Teflon packing cup	2
	500222	Peek bearing	1
	500227	Teflon packing cup	2
	500228	Peek bearing	1
	500237	Viton O-ring	1
500248	Teflon O-ring	1	

8.0 TROUBLESHOOTING

Problem	Causes	Recommended Solutions
Pump does not operate.	Air supply or pressure is inadequate. Air lines restricted. Dispensing valve is not open or clogged. Clogged fluid lines, valves, hoses or damaged air motor. Low or exhausted fluid supply.	Increase air pressure. Check for any restrictions in air line. Open and/or clear valve. Follow pressure relief procedure to clear obstruction. Service air motor. Replace parts as necessary. Refill fluid. Prime system and/or flush it.
Non-stop air exhaust.	Worn or damaged air motor gasket, packing, seals, etc	Service air motor. Replace parts as necessary.
Erratic pump operation.	Intake valve or packing worn off. Intake valve is not completely closed.	Refill fluid. Prime system or flush it. Clear obstruction and service pump. Replace parts as necessary.
Low output on upstroke.	Held open or worn intake valve.	Clear obstruction and service pump. Replace parts as necessary.
Low output on down stroke.	Held open or worn intake valve.	Clear obstruction and service pump. Replace parts as necessary.
Low output on both strokes.	Restriction in air lines or air pressure low. Closed or clogged valves. Fluid supply is insufficient or exhausted. Obstructions in fluid lines, hoses, valves, etc.	Increase air pressure or supply. Open valve or clear valve. Refill fluid. Prime system or flush it. Follow pressure relief procedure to clear obstruction.

9.0 TECHNICAL SPECIFICATIONS

Recommended application chart

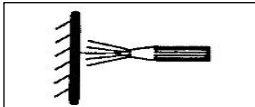
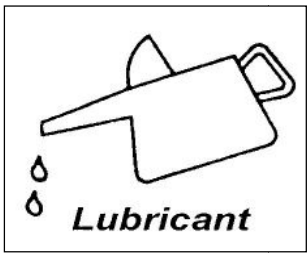
Industry	Application	Viscosity Range(CPS)
 Chemical	Alcohol	0-100
	Dye	0-1000
	Methyl Chloride	0-200
	Solvents	0-500
 Surface Finishing Material	Paint(Latex)	100-1000
	Paint(Oil base)	100-800
	Sealer(Wood)	100-800
	Stain(Oil base)	100-1000
 Lubricant	Anti-Freeze	30-100
	Die Lubricant	30-50
	Gear Oil	200-1000
	Lubricant	100-1500
	Mold Release Agent	30-100
	Oil	100-500

Air pressure requirements: For optimum pump performance, 80 PSI should be supplied to the IP02 series transfer pumps.

Pump viscosity guide

All calculations in Centipoise (cps)

IP01 series pumps: 1 – 2,000 cps

IP02 series pumps: 1 – 4,000 cps

OP series pumps: 1 – 4,000 cps

IP05 series pumps: 1 – 10,000 cps

IP10 series pumps: 1 – 20,000 cps

Calculations are based on the following general guidelines

- Inbound air pressure: 100 psi
- Pressure at dispense point: 0 psi
- Hose/pipe length w/smooth inner surface = L: 25 feet
- Hose size = D: 3/4"
- Flow rate = Q: 2 gpm
- Viscosity = V: cps
- Pressure loss in hose/pipe (psi), P: $P = 0.0273QVL/D^4$

The above viscosity values are only general guidelines. Other factors should always be taken into consideration such as; dispensing valves, fittings, hose unions, elevation, outside ambient temperature, etc.

810201, 810202, 810203, 810204



Air Operated Fluid Pump

Divorced Design

Technical Specifications

Fluid Ratio..... 2:1
 Max. Output Flow (intermittent)(Stubby)..... 2.5 gpm (9.5 lpm)
 Max. Output Flow (intermittent)(drum)..... 3.75 gpm (11.7 lpm)
 Max. Output Flow (continuous)(stubby)..... 2.0 gpm (7.6 lpm)
 Max. Output Flow (continuous)(drum)..... 2.5 gpm (9.5 lpm)
 Maximum Output Pressure..... 360 psi (24.8 bar)
 Maximum Air Input Pressure..... 180 psi (12.4 bar)
 Air Inlet Port..... 1/4 npt(f)
 Fluid Outlet Port..... 3/4 npt(f)
 Fluid Inlet Port (stubby)..... 3/4 npt (f)
 Rod & Piston Packings..... Teflon®
 Other Seals..... Viton®
 Rod & Cylinder..... Carbon Steel or Stainless Steel
 Other Wetted Parts..... Carbon Steel or Stainless Steel
 Weight stubby/drum..... 11.5 lbs. (5.2 Kg.)/17 lbs. (7.7 Kg.)
 Package Dimensions & Weight:
 IP-02...4"x4"x54" (102mm x 102mm x 137cm) 19 lbs. (8.6 Kg.)
 IP-02S...4"x4"x35" (102mm x 102mm x 889mm) 16 lbs. (7.26 Kg.)

Performance

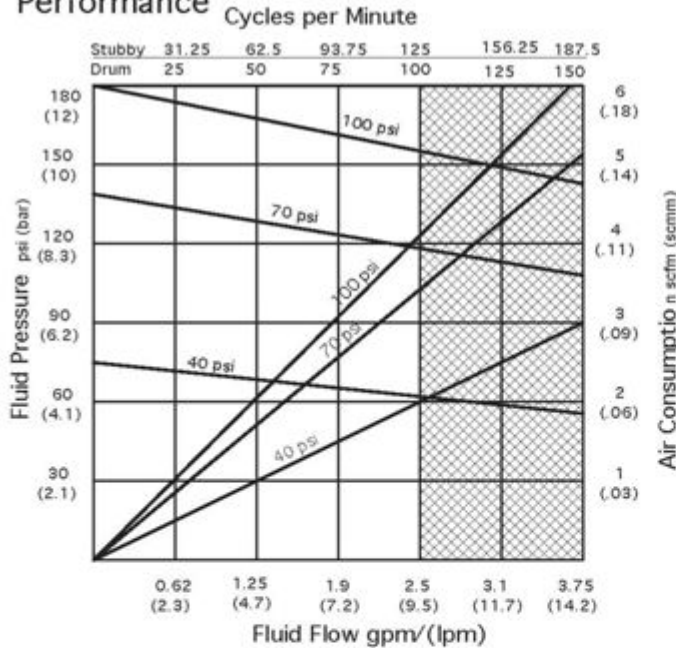

Dimensions

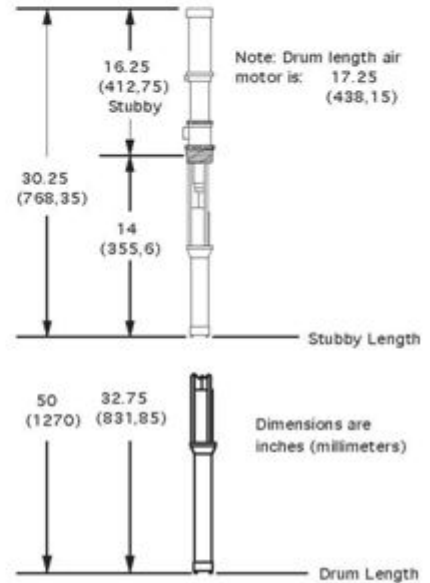

How to Read Performance

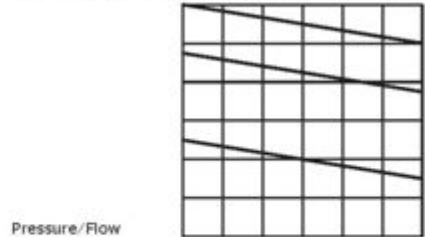

Pressure/Flow

1. Locate required flow along bottom edge of chart.
2. Follow vertically to bold line for input air pressure.
3. Follow horizontally to left edge of chart to read maximum available fluid pressure.

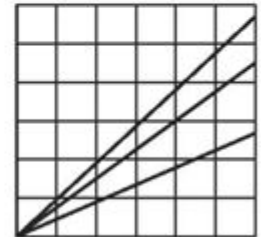

Air Consumption

1. Locate fluid flow along bottom edge of chart.
2. Follow vertically to bold line for input air pressure.
3. Follow horizontally to right edge of chart to read air consumption.

100 Series 2:1

Air Operated Fluid Pump



IPM's IP-02 series of pumps are specifically designed for use with difficult to handle materials. The immersed lower pump, tie tubes, and sealing bung bushing allow quick drum change without exposing the system to contamination and moisture.

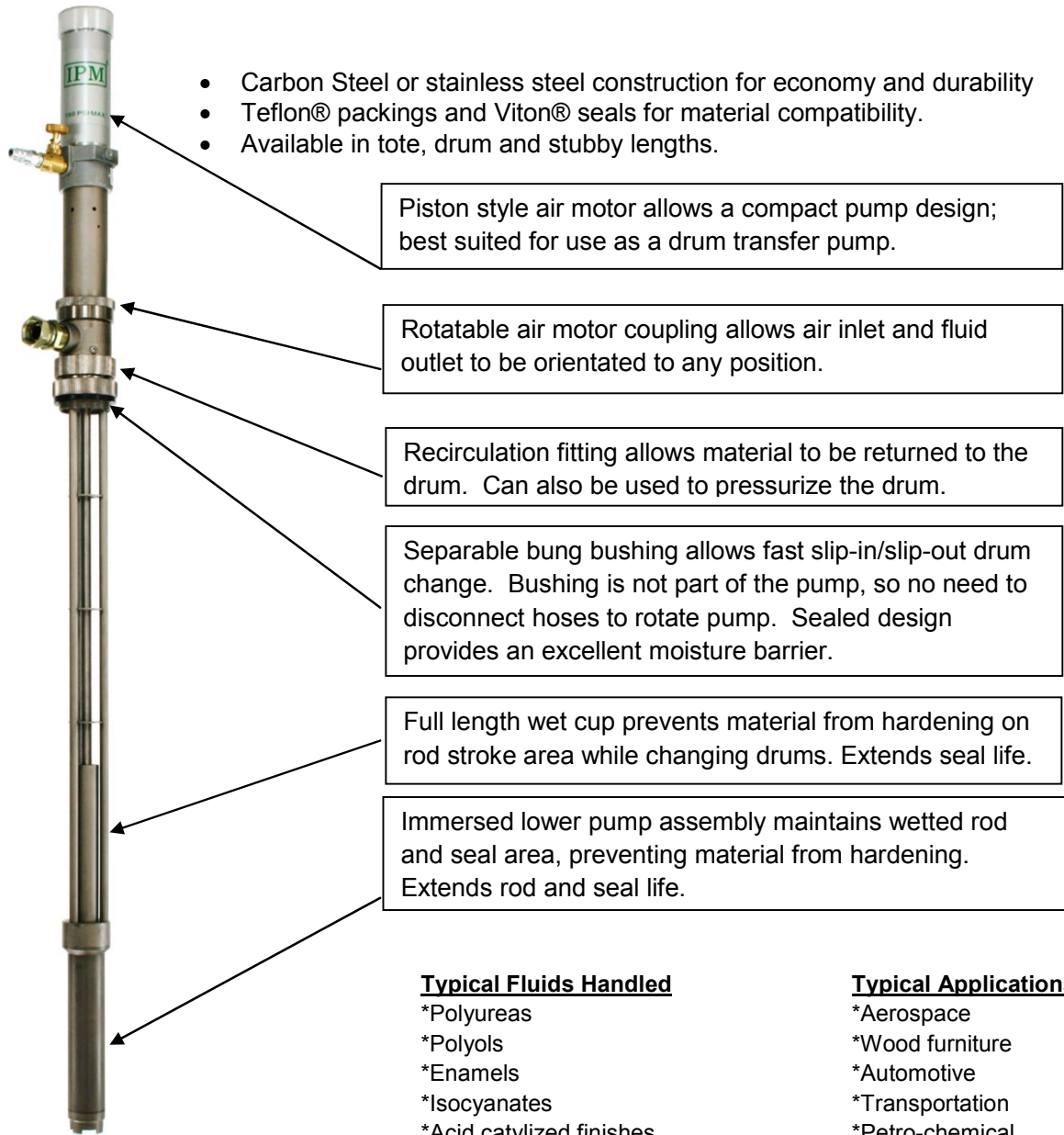

International Pump Manufacturing
Phone: 253-863-2222 Fax: 253-863-2223

3107 142nd Ave East Suite #106
Sumner, WA. 98390

Web: www.ipmpumps

Email: sales@ipmpumps.com

10.0 WARRANTY AND DISCLAIMER

WARRANTY

International Pump Manufacturing, Inc. (hereafter designated IPM) warrants the equipment it manufactures to be free of defects in materials and workmanship for a period of one (1) year from the date of sale from IPM to an authorized IPM distributor or to the original end user and/or purchaser. IPM will, at its discretion, repair or replace any part of the equipment proven to be defective. This warranty applies only when the equipment is used for the intended purpose and has been installed, operated and maintained in accordance with written operating procedures.

A condition of the warranty is the prepaid return of the equipment to an authorized distributor of IPM who shall provide verification of the warranty claim. IPM will repair or replace free of charge any parts found and verified to be defective or damaged upon receipt of equipment. Shipping will be prepaid for the repaired or replaced parts under warranty. Should inspection of the equipment reveal no defects in material or workmanship repairs will be made at the standard IPM rate, which will include parts, inspection, labor, packaging and shipping.

The warranty does not apply nor shall IPM be liable for damage, operational wear, malfunction of equipment caused by improper installation, misuse, chemical abrasion or corrosion, operator negligence, accident, tampering or altering of equipment, lack of improper maintenance and/or by substitution of non-IPM parts. Additionally, IPM shall not be liable for nor does the warranty apply to operational wear, damage or malfunction caused by incompatibility of accessories, components, structures, equipment or materials not supplied by IPM. The warranty does not apply to nor will IPM be responsible for the improper operation, maintenance, design, manufacture, installation of components, accessories, equipment or structures not supplied by IPM.

The warranty is void unless the Warranty Registration Card is properly completed and returned to IPM within ONE (1) month of the date of the sale.

LIMITATIONS AND DISCLAIMER

This warranty is the sole and exclusive remedy for the purchaser. No other warranties, expressed or implied, warranties for fitness of purpose or merchantability, or non-contractual liabilities are made by IPM, including product liability, whether on negligence or a strict liability basis. Liability for directly special or non-contractual damages or loss is expressly excluded and denied. IPM's liability shall in no case exceed the amount of the purchase price.

IPM does not warrant and disclaims implied warranties of merchantability and fitness for a particular purpose, components, accessories, equipment, materials sold but not manufactured by IPM. These parts (valves, hoses, fittings, etc.) are subject to the provisions within the warranty of the actual manufacturer of these items. IPM will provide reasonable assistance with warranty claims on these items.



**3107 142nd Avenue East, Suite 106
Sumner, Washington 98390
Telephone: (253) 863-2222 Fax: (253) 863-2223
Website: ipmpumps.com Email: sales@ipmpumps.com**

Revised: 1 January 2011